



**STAR  
WARS**



9499



1

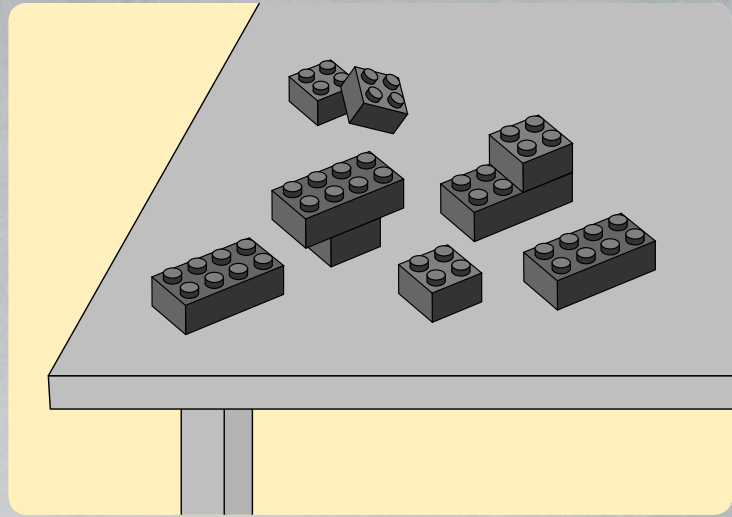
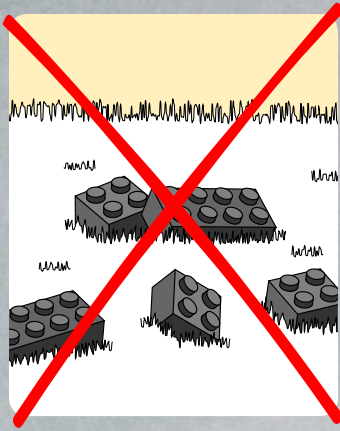

2

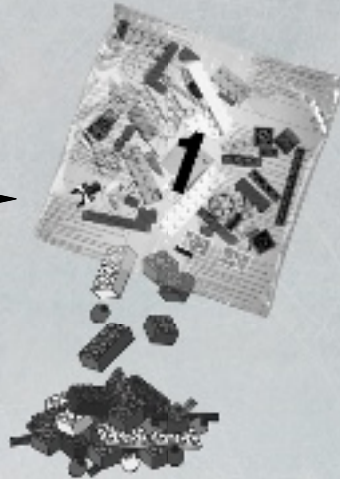
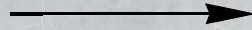

<http://lego.com/brickseparator>

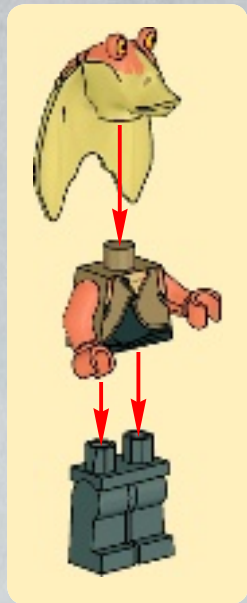
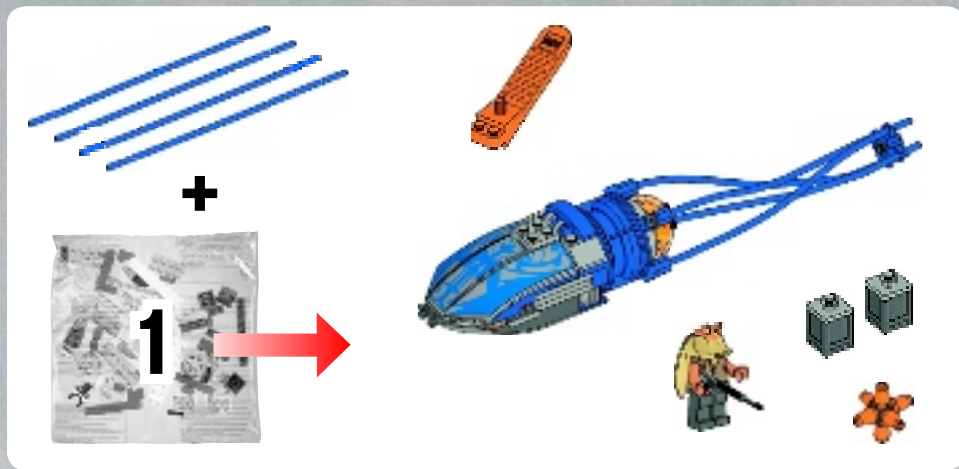

1



2



3



1

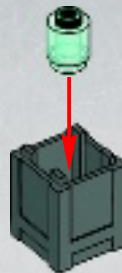

2

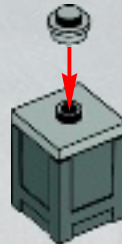

2x

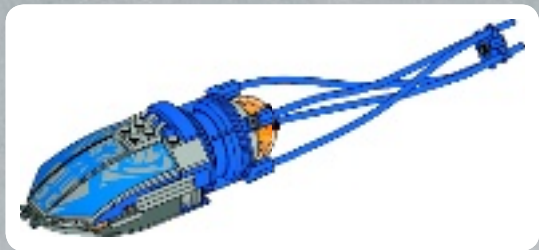

1x

1



2x

2

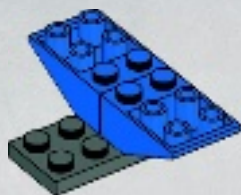

4

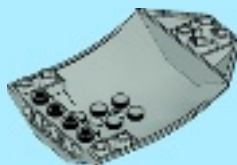

1x

3

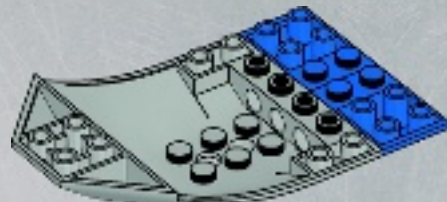

1x

4

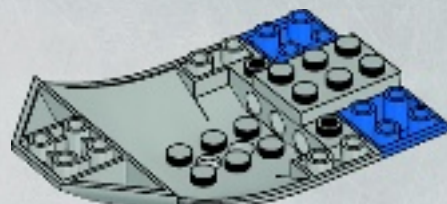



1x



2x

5

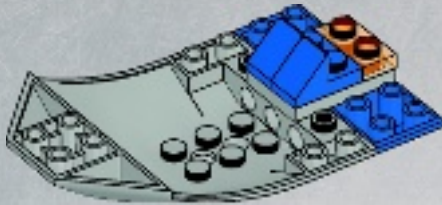

2x



2x

6

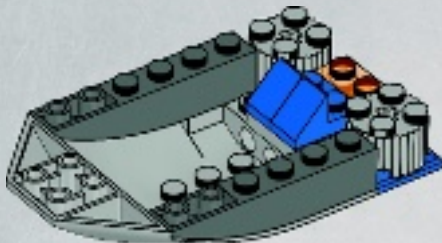

2x



1x



1x

7

1

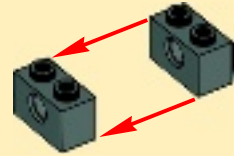

2



3

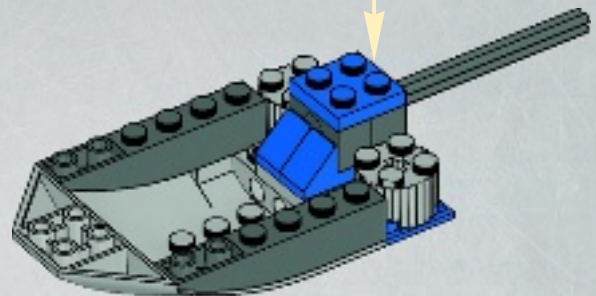
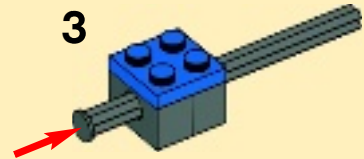

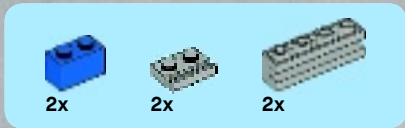

8

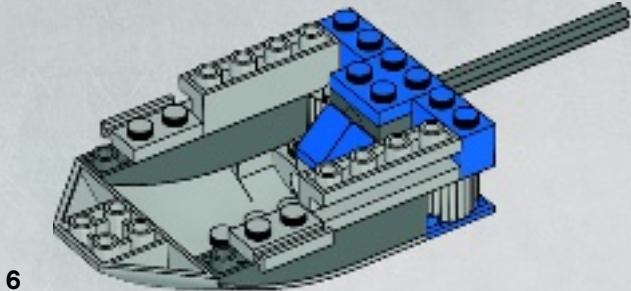

6



9

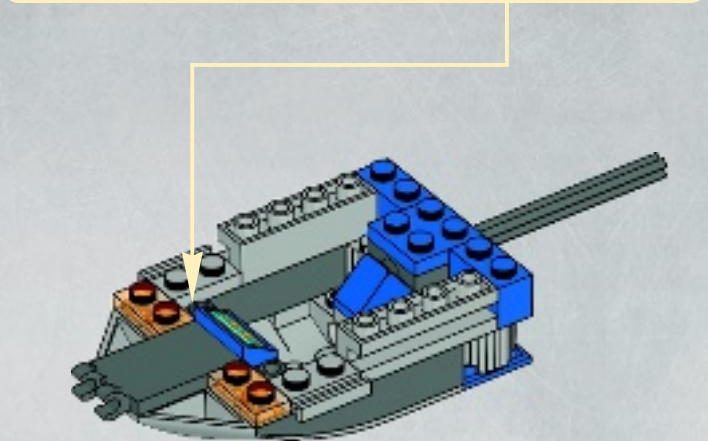
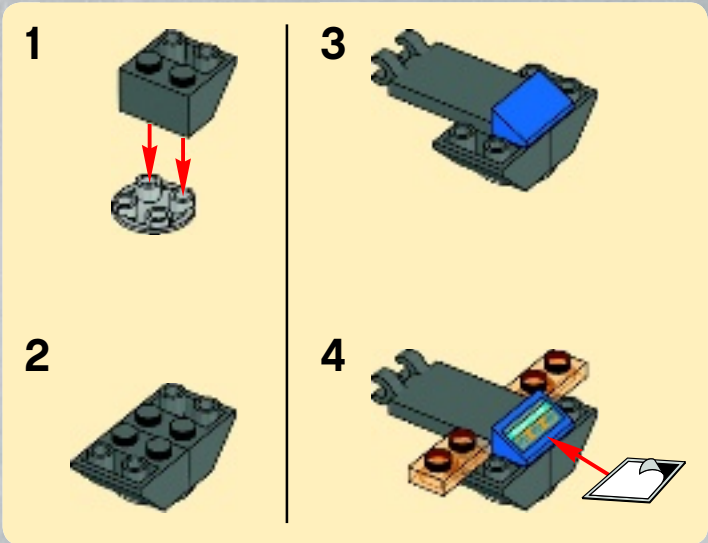



1x



2x



2x

# 10

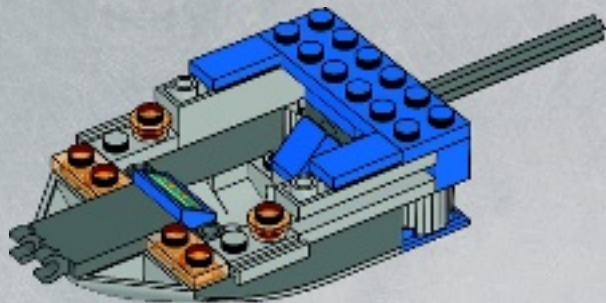

2x

# 11

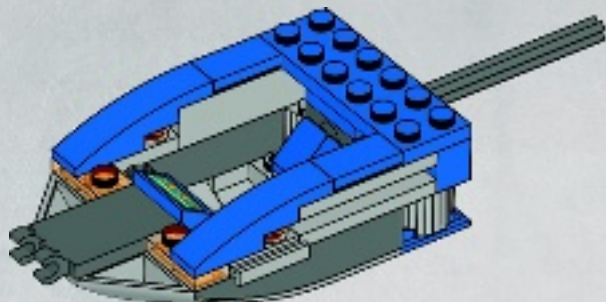

3x

# 12

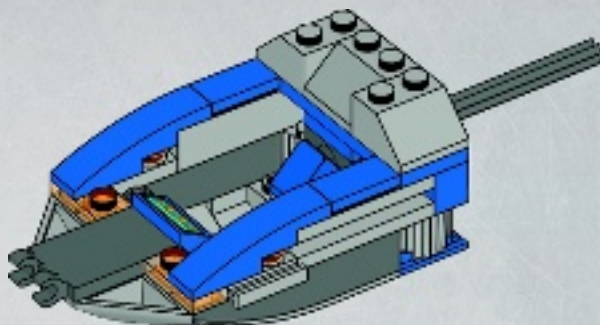



1x



1x

# 13

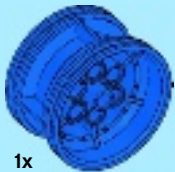
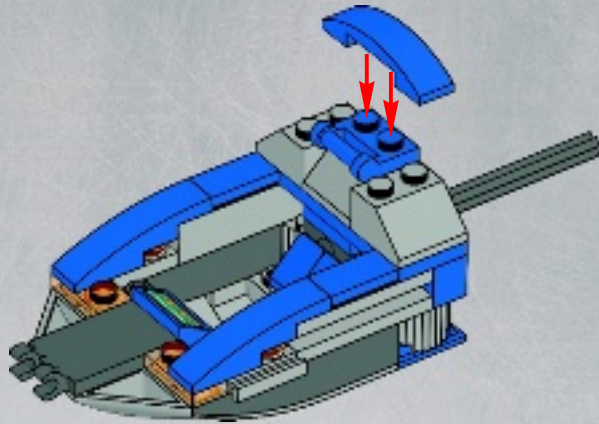

1x

# 14

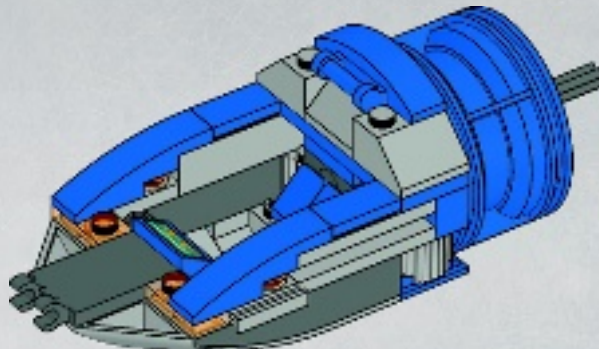



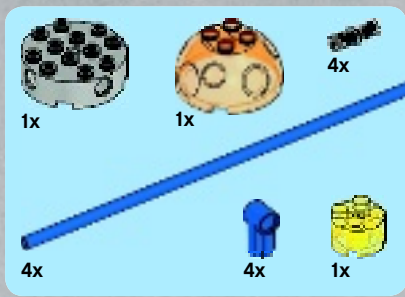

15

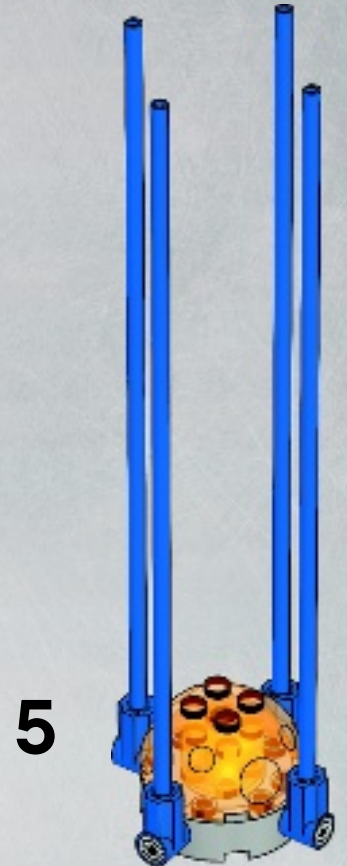

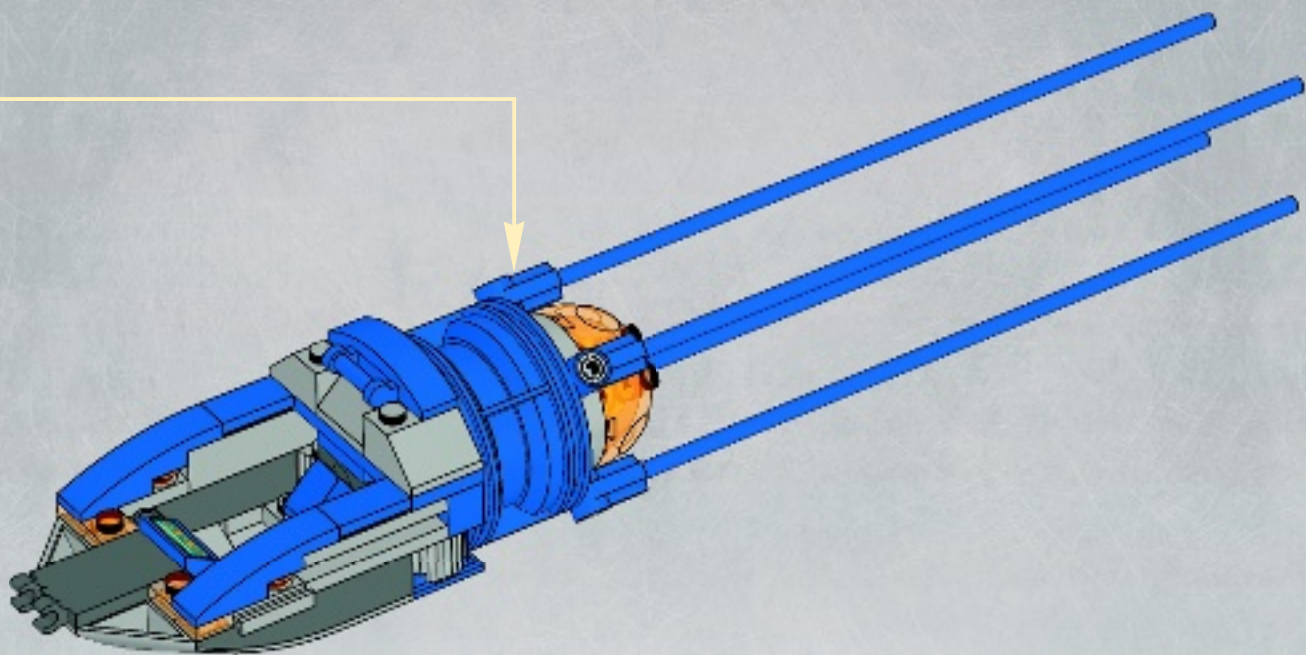



1x



4x

# 16

1



2

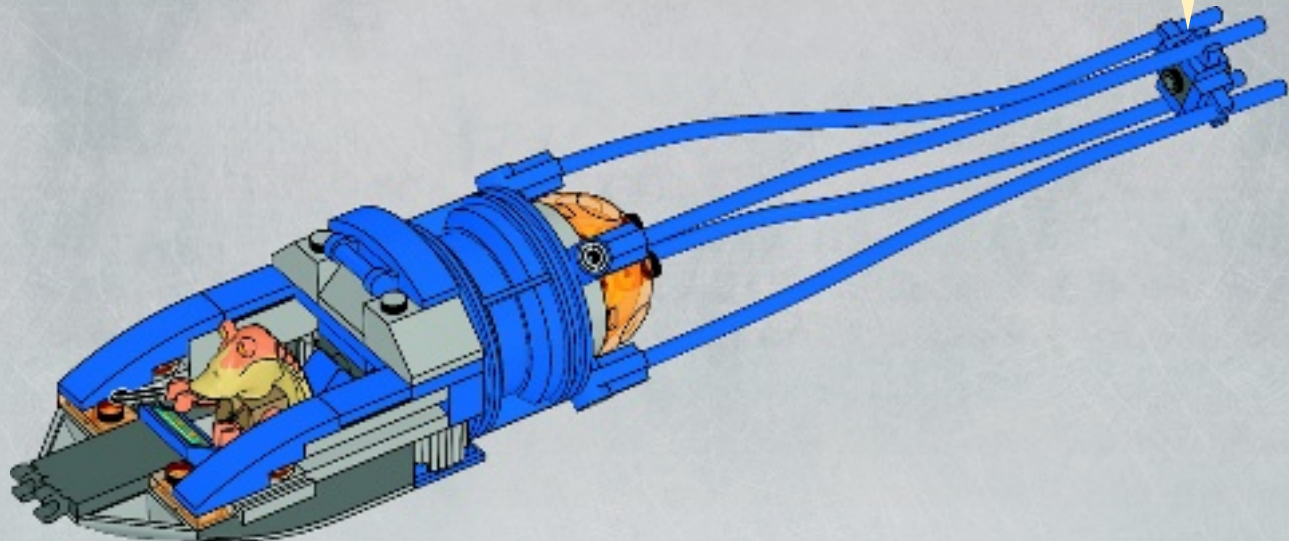
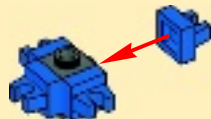

17

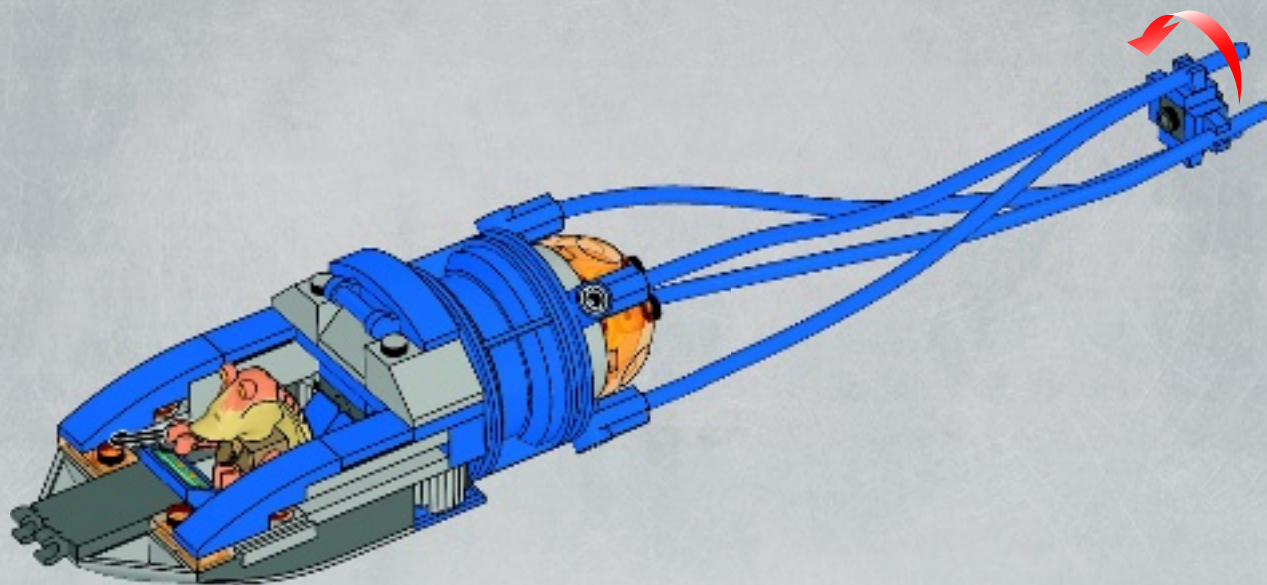



18

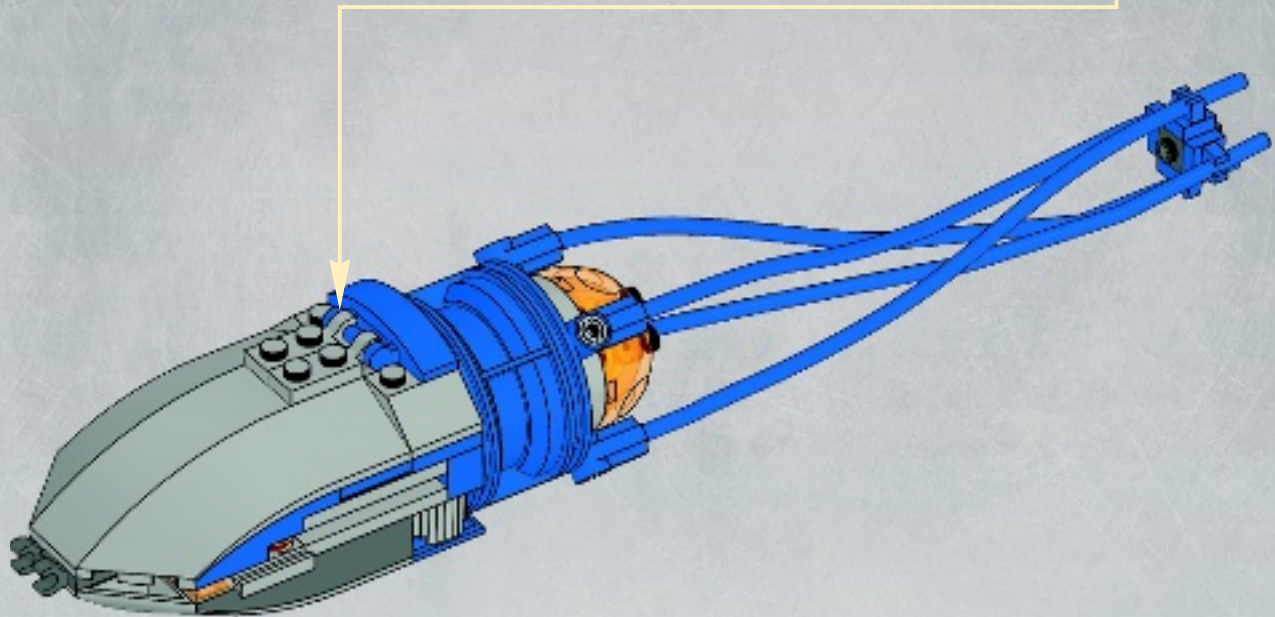
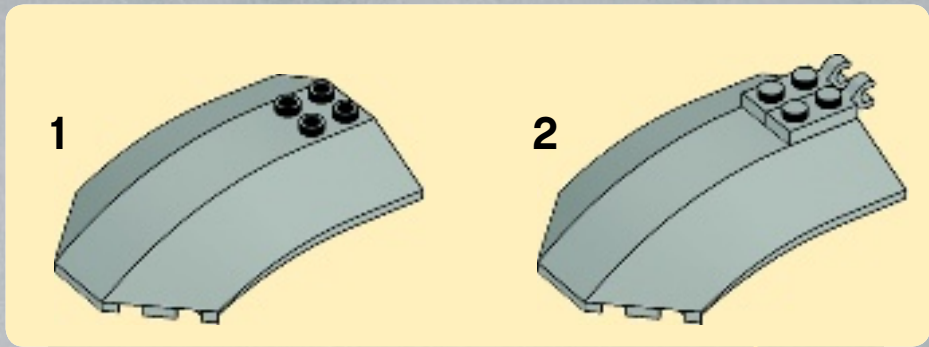

19

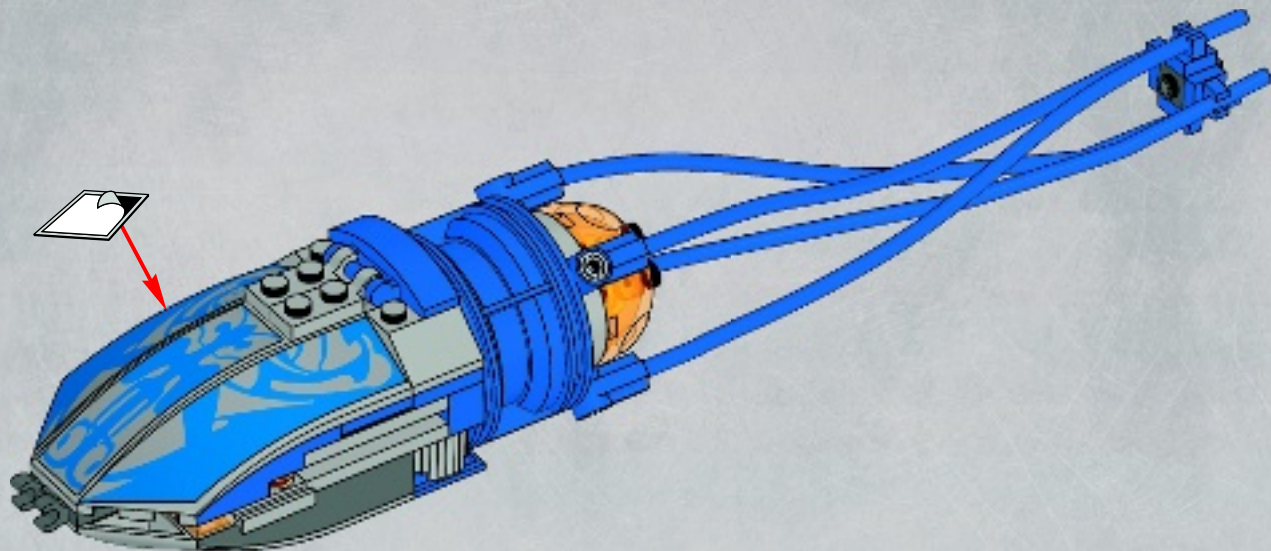

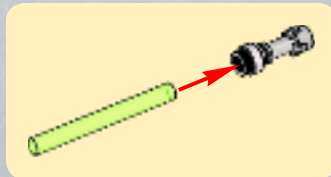
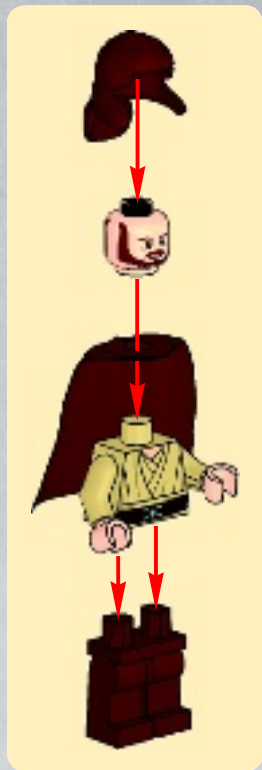

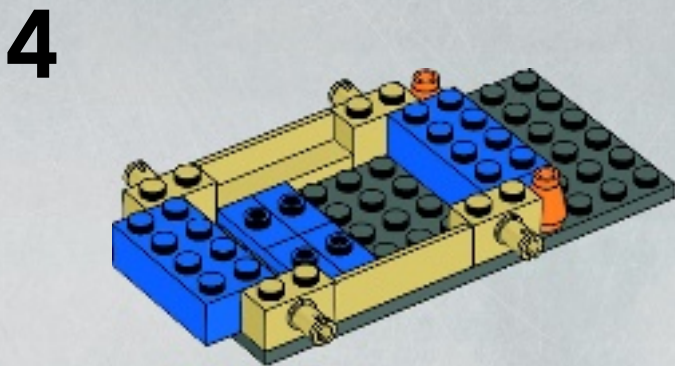
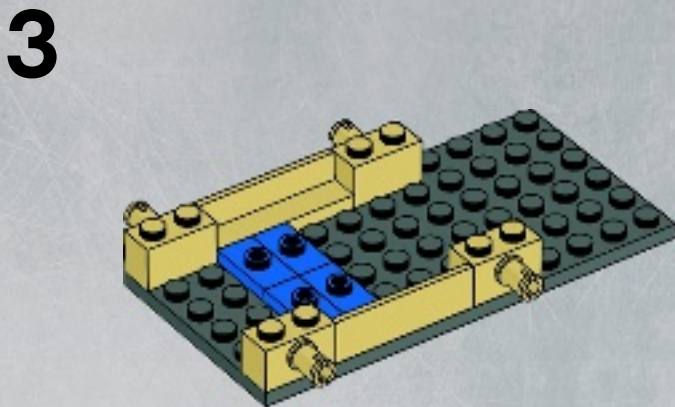
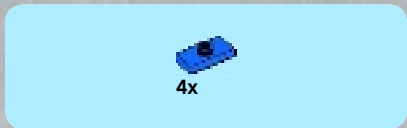
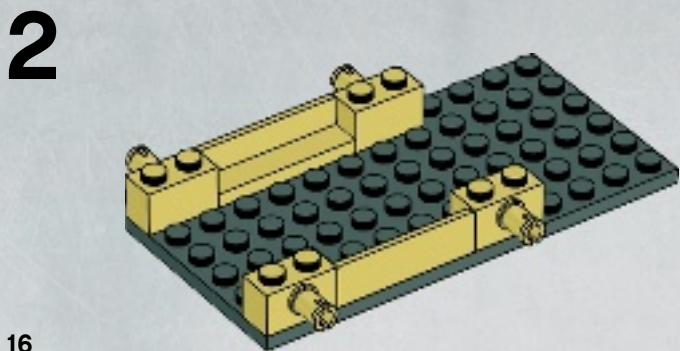
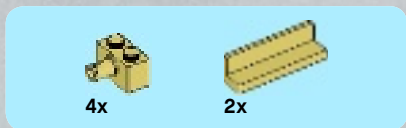
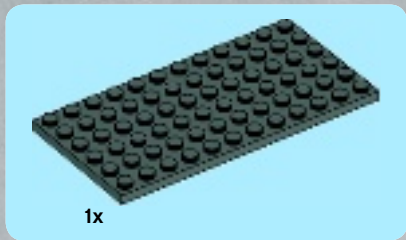





2x

5

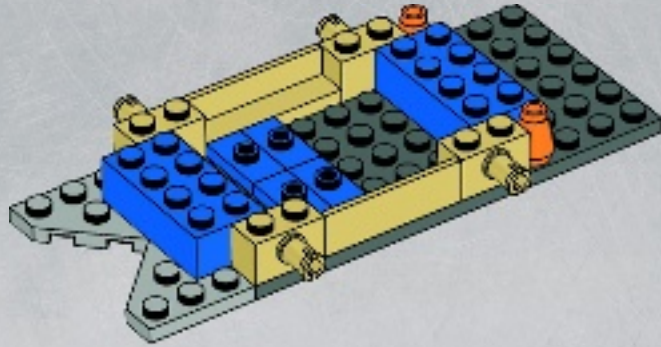

2x

6

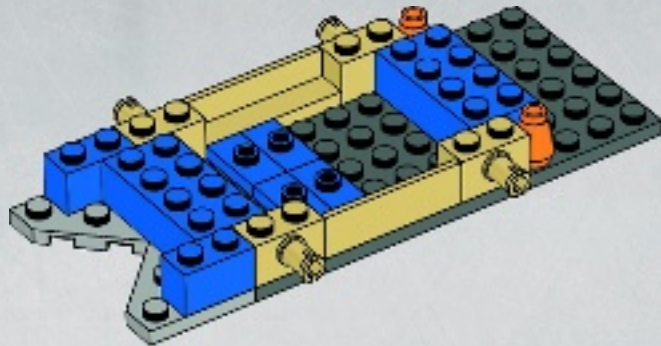



2x



2x

# 7

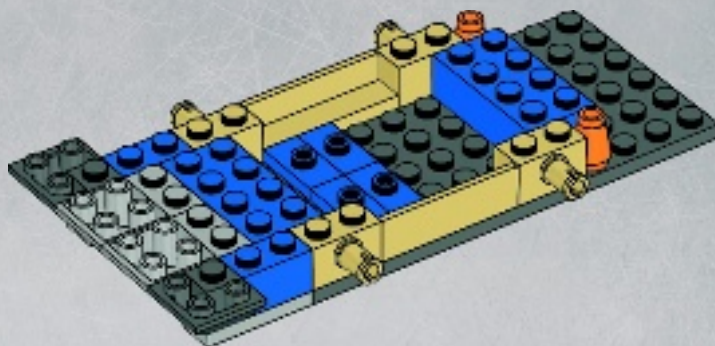

1x



1x

# 8

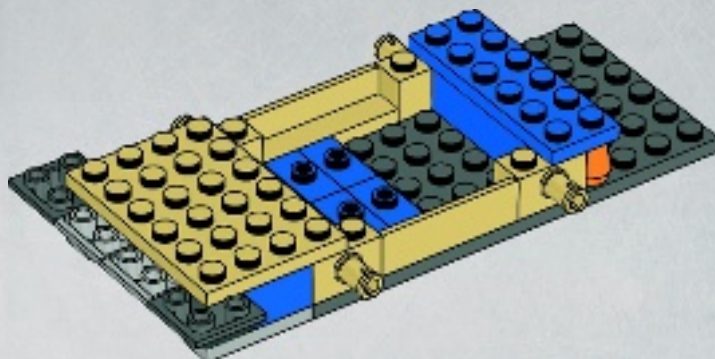

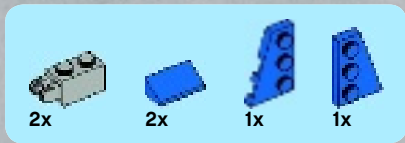

9

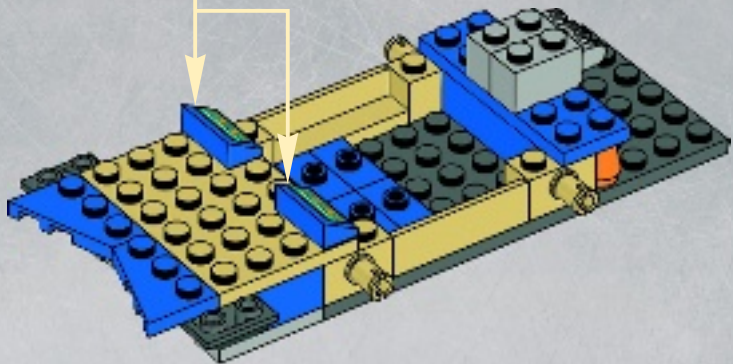
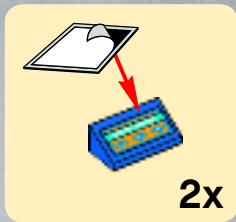

10

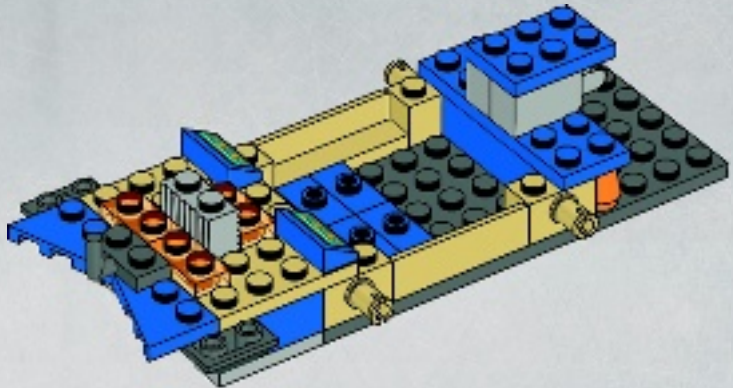



2x



1x

# 11

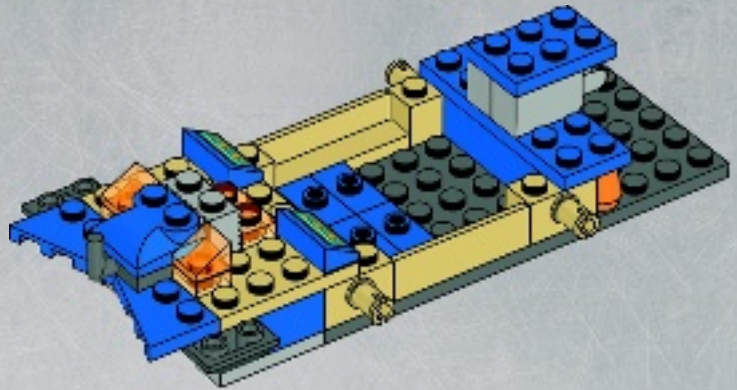

1x



1x



1x



1x

# 12

1

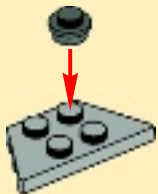

2

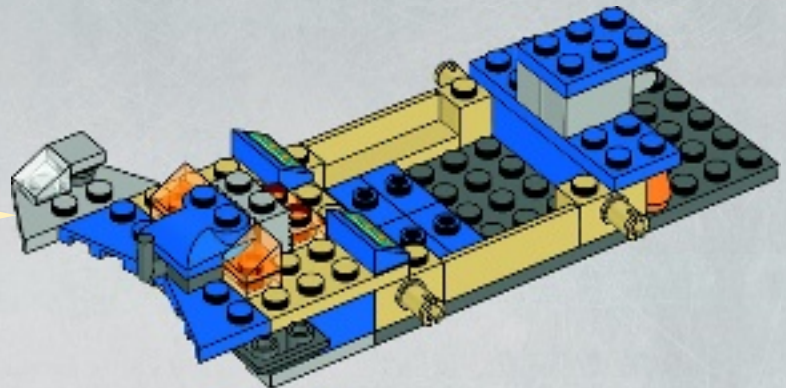



1x



1x



1x



1x

# 13

1

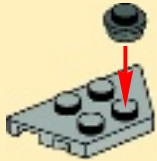

2

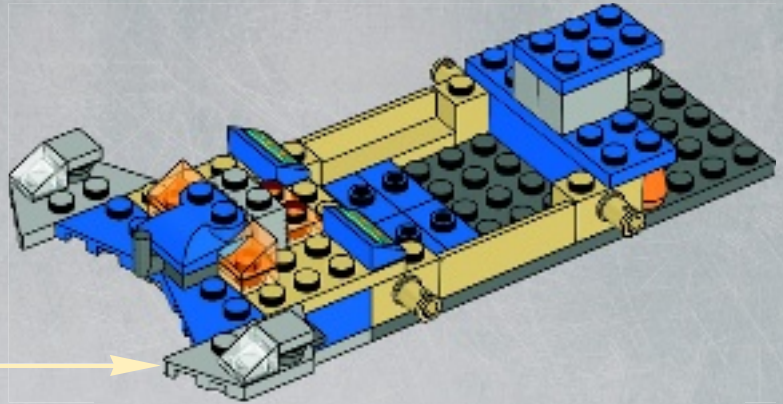

2x



2x

# 14

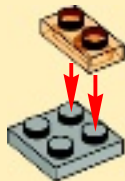

2x

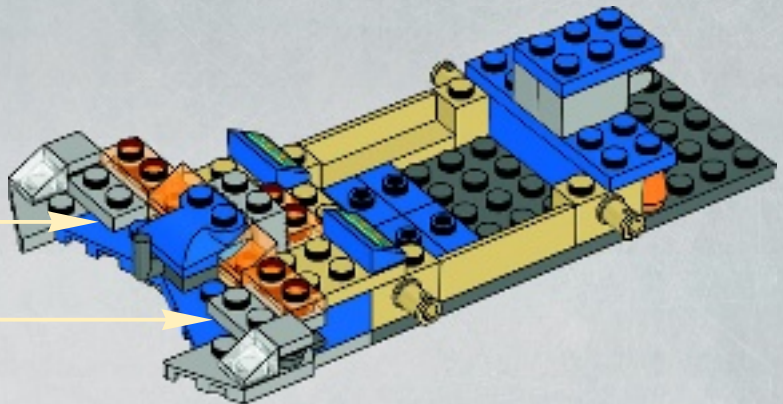



15

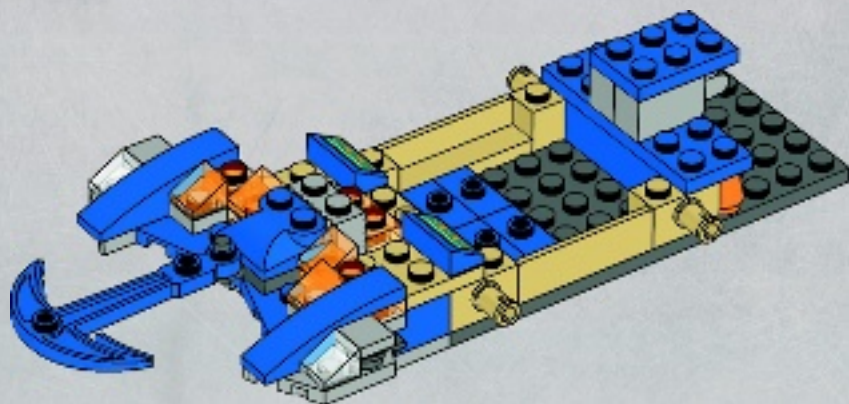

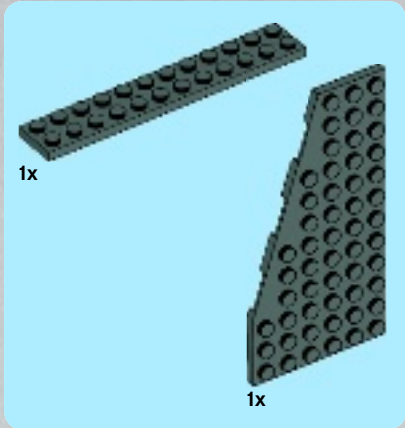
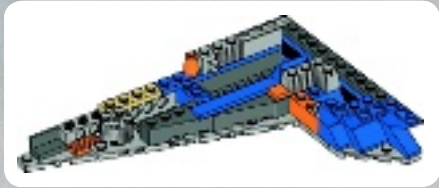
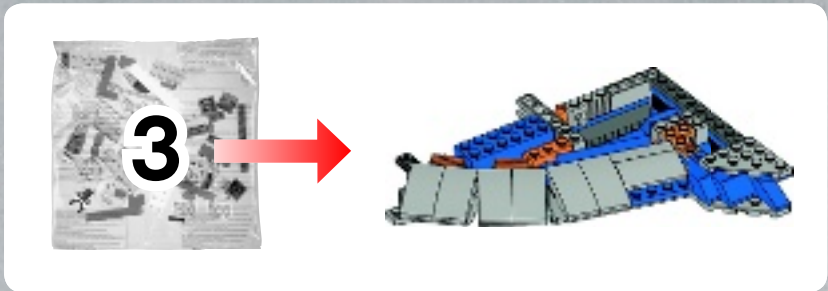

1

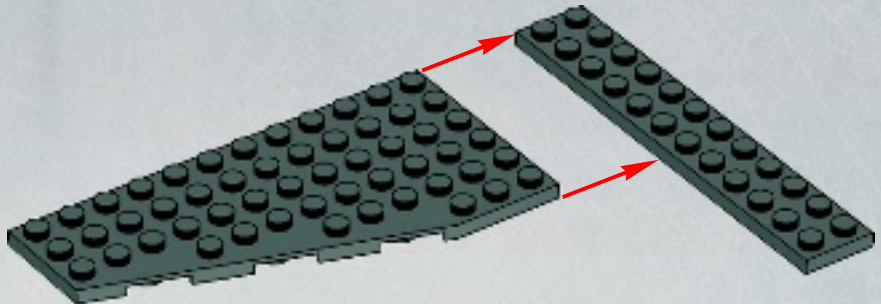

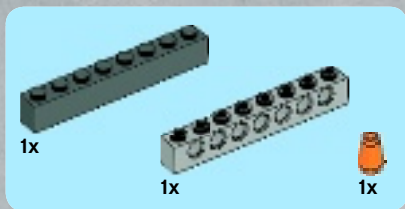

2

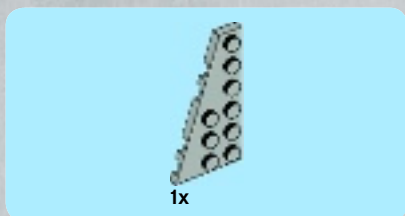
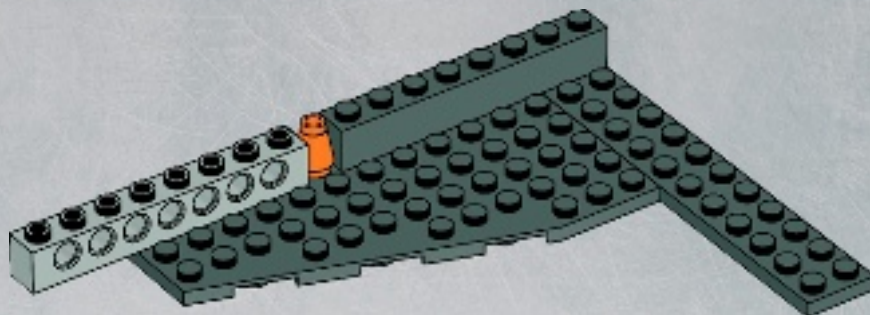

3

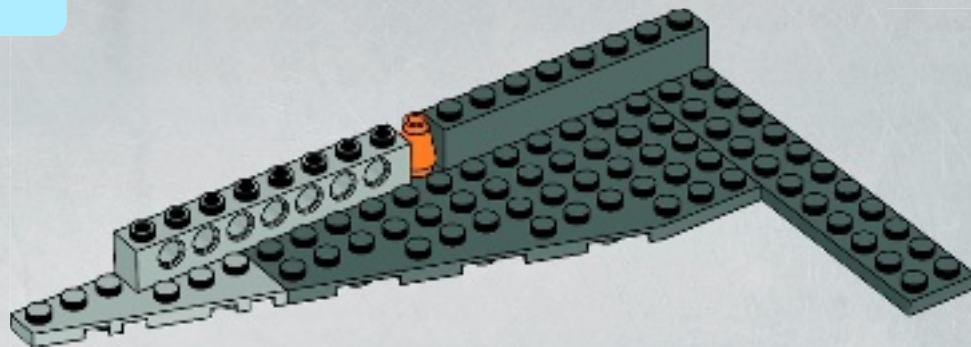





1x



1x



1x

# 4

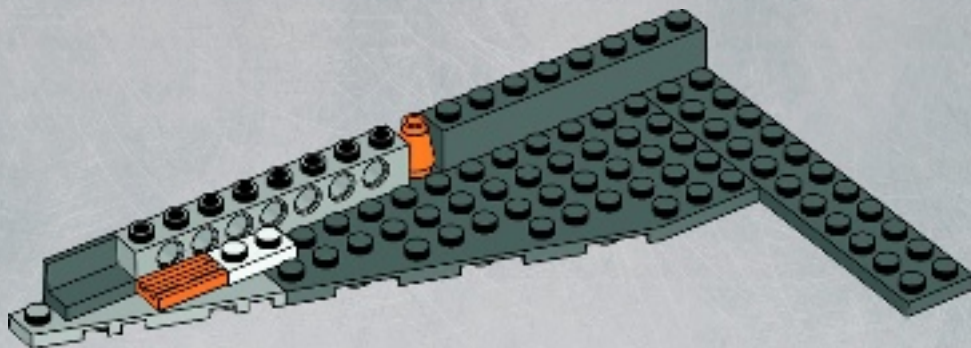

1x



1x

# 5

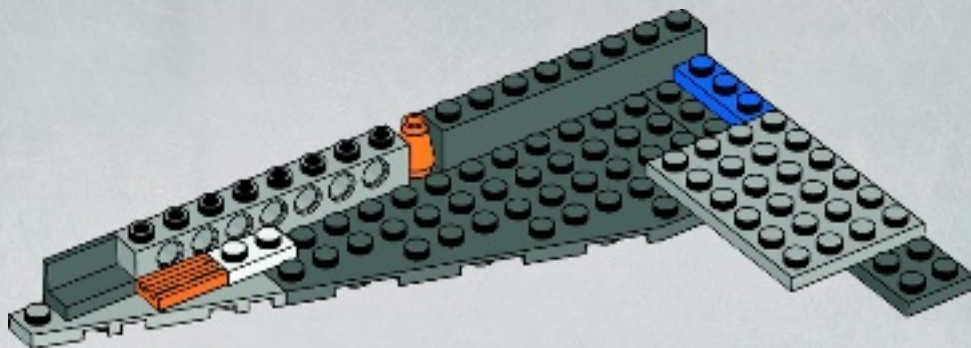

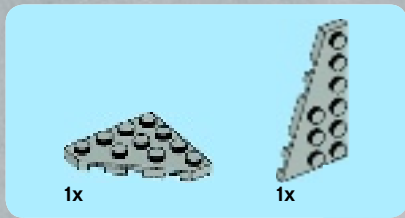

6

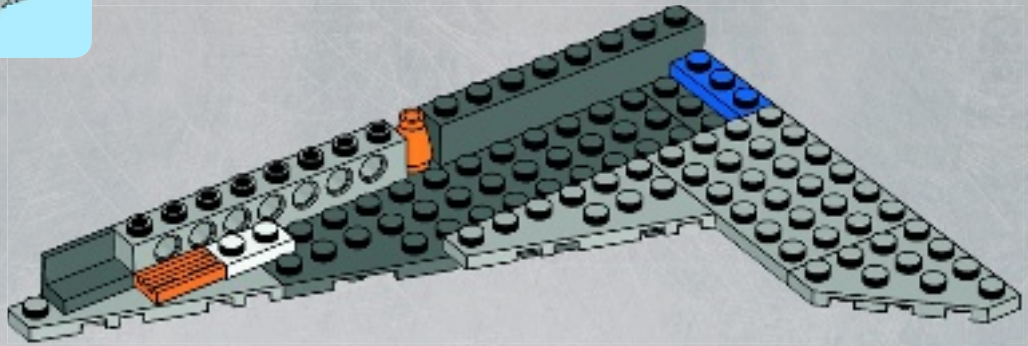

7

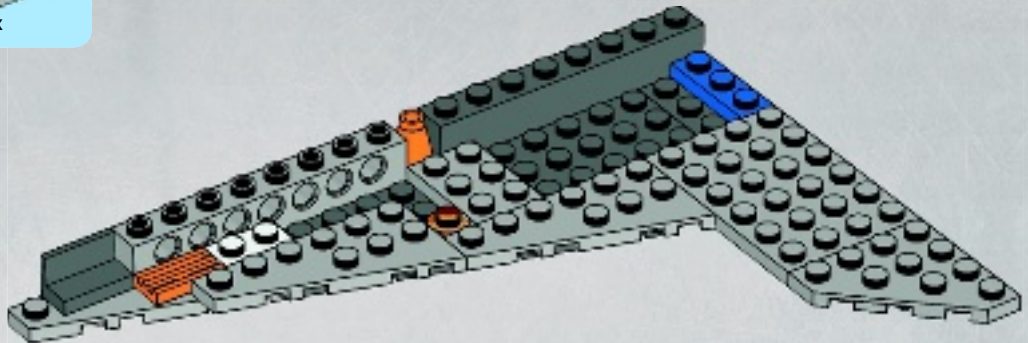

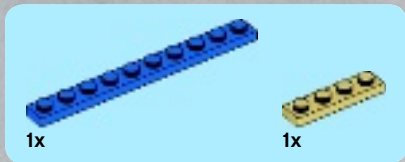

8

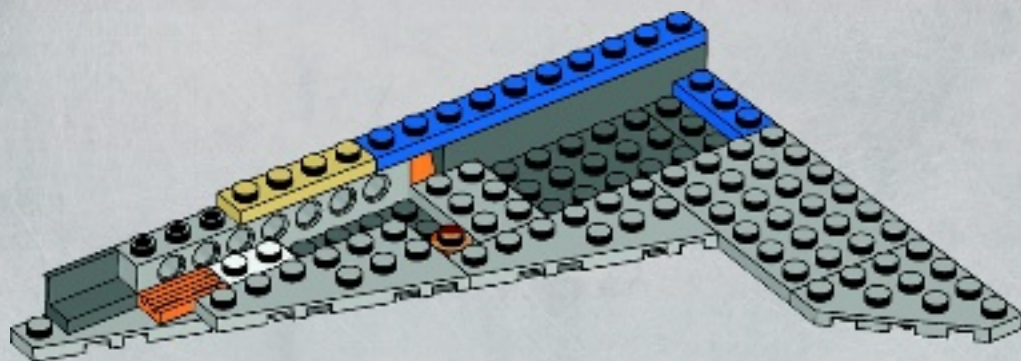

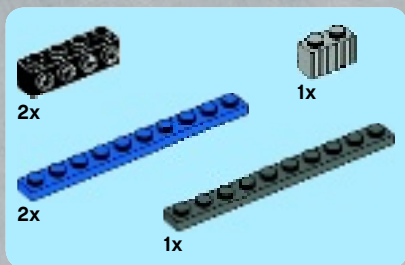

9

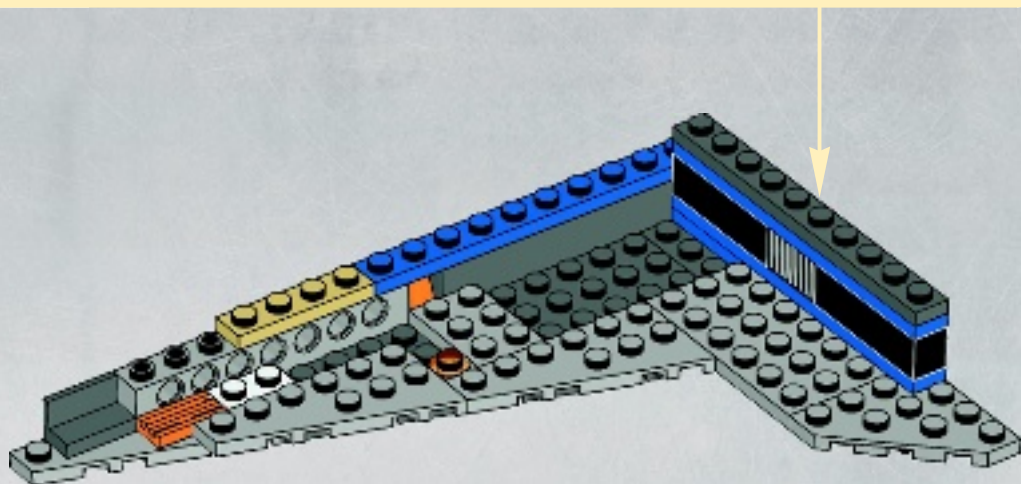
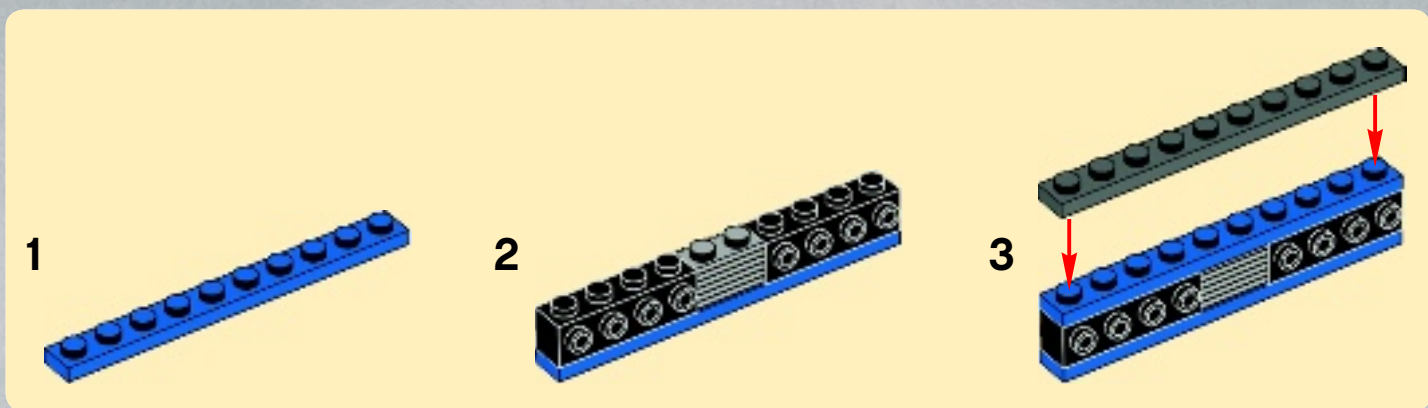



1x



1x



1x

# 10

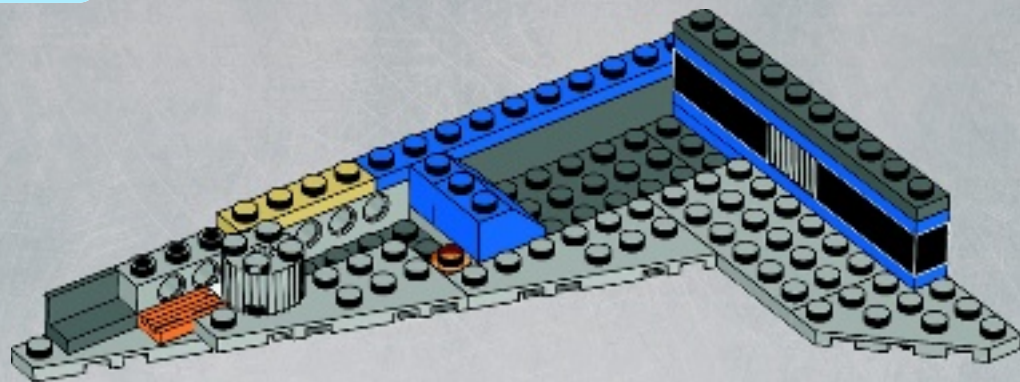

1x



2x

# 11

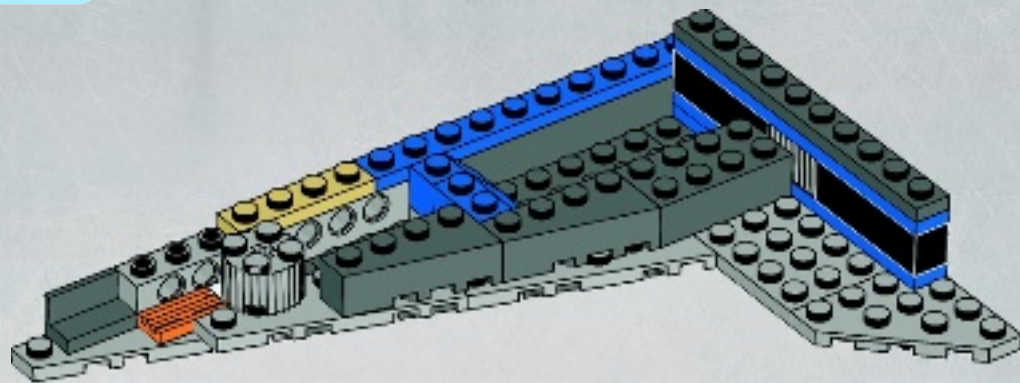



1x



1x

# 12

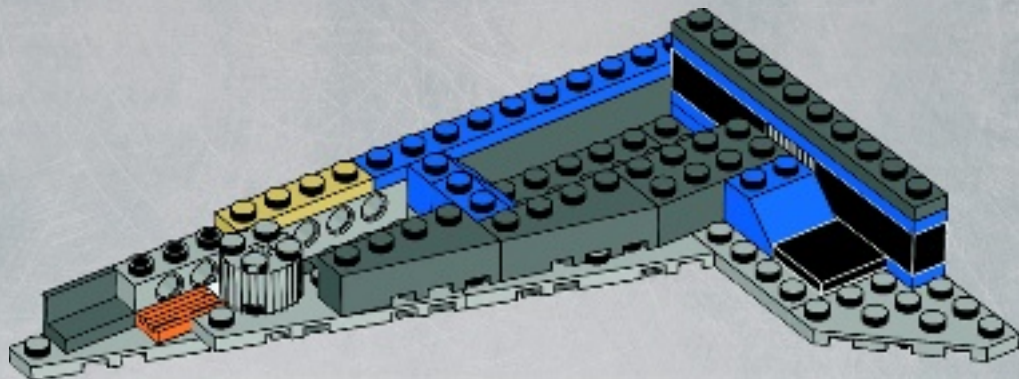

1x



1x



1x



1x

# 13

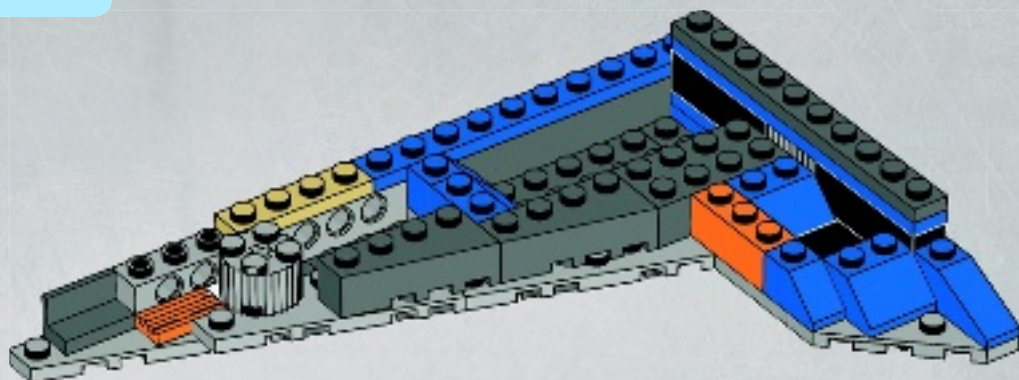

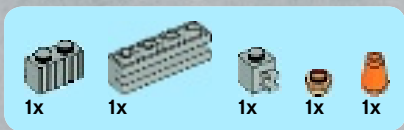

14

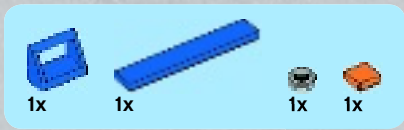
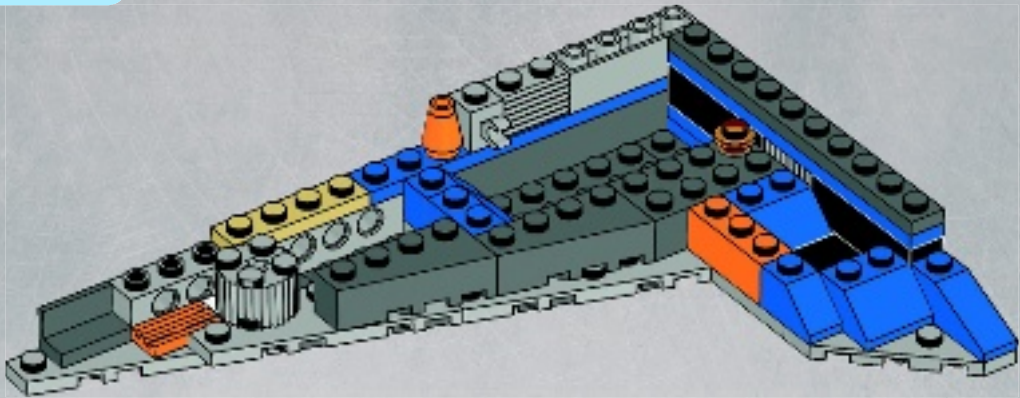

15

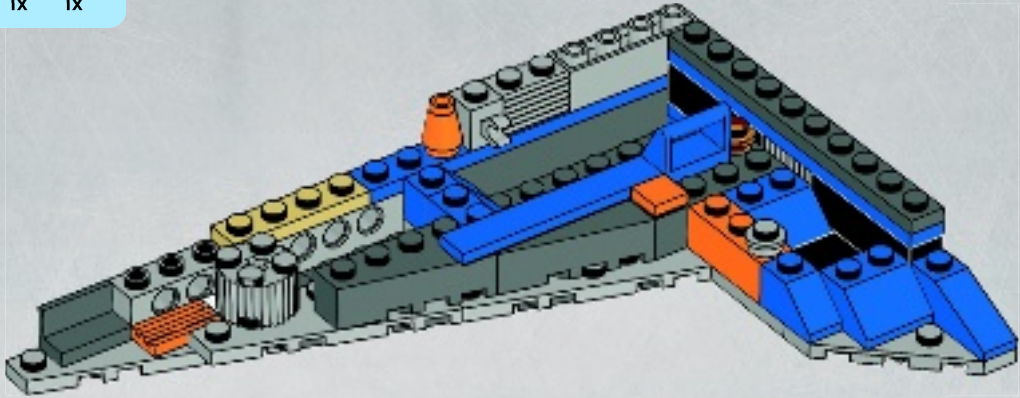



16

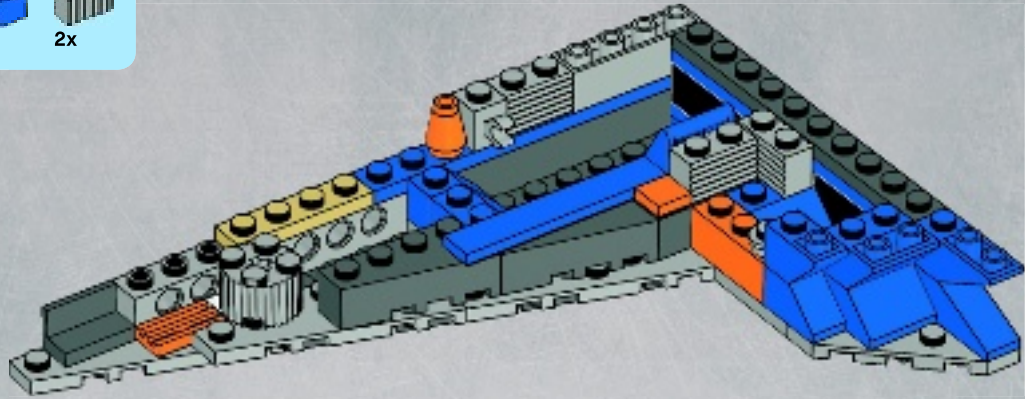

17

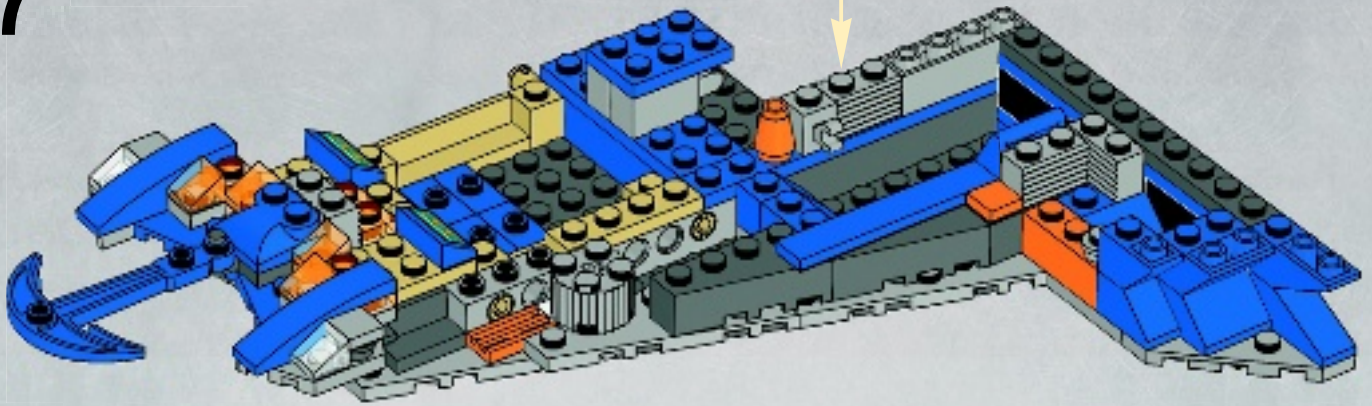





1x



1x

# 18

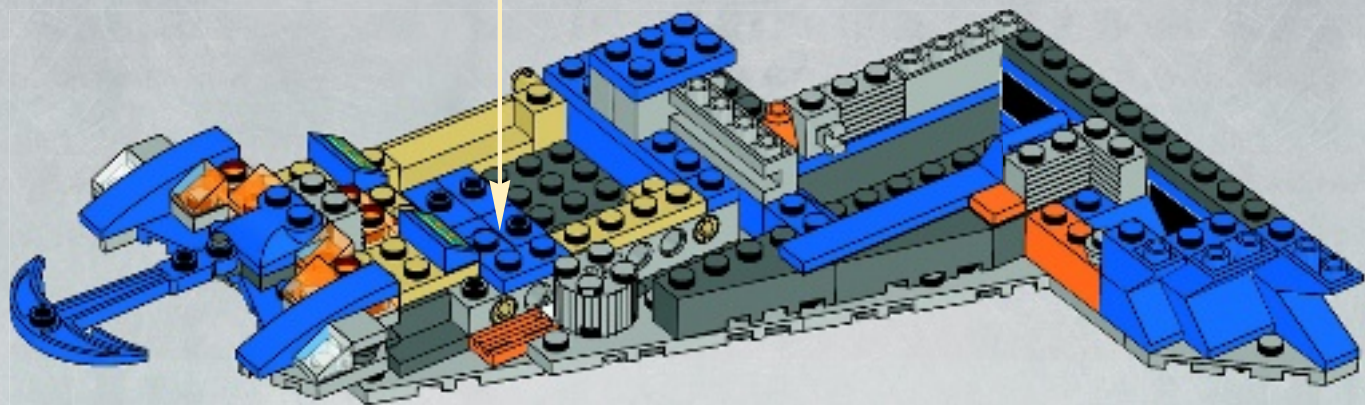
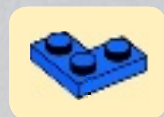

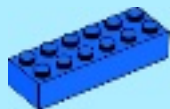

1x



1x

# 19

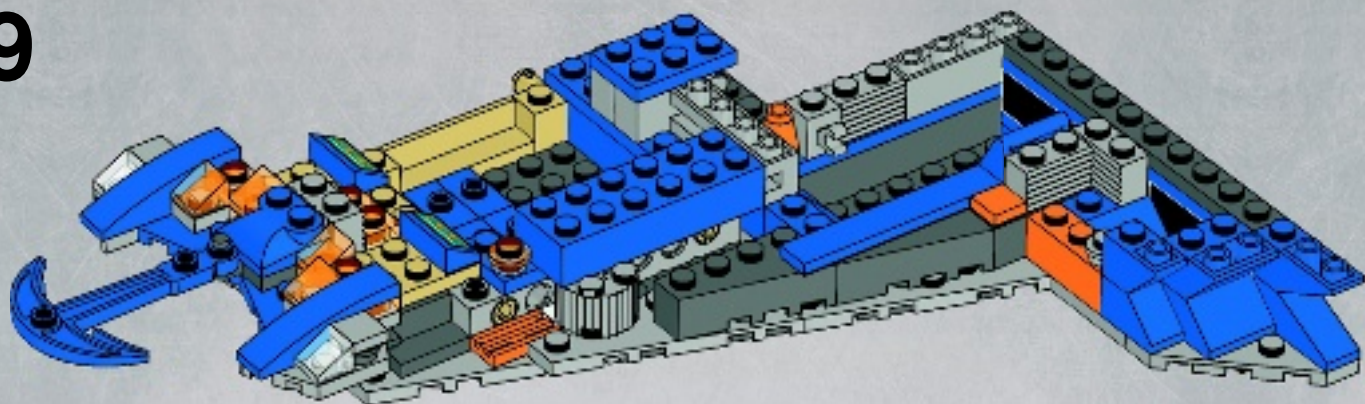

1x



1x



1x



1x

# 20

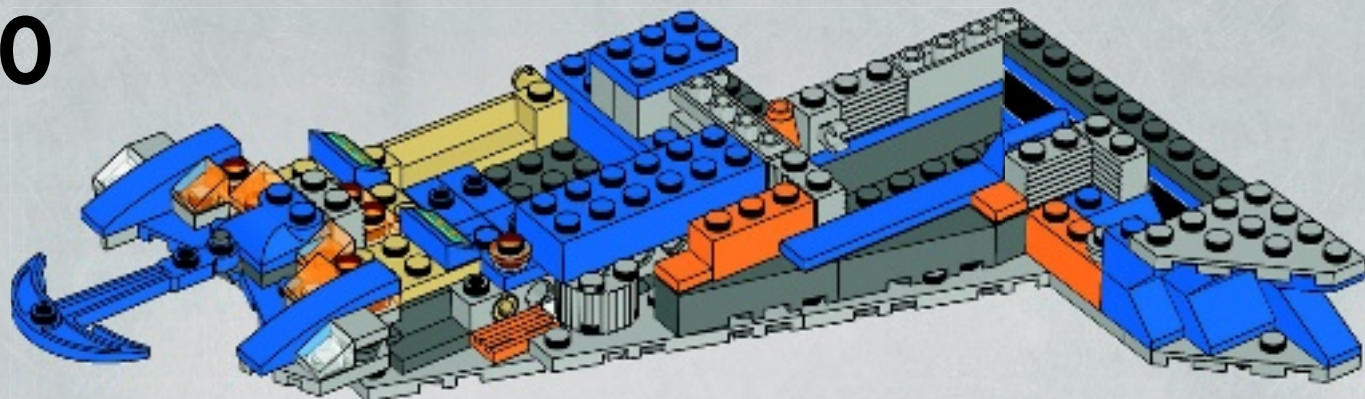

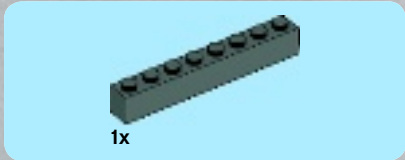

1x

1



1x

2

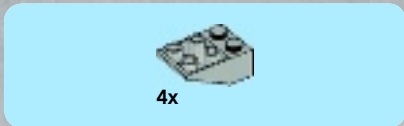

4x

3

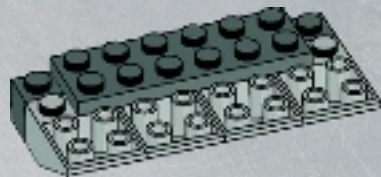

2x

1x

4

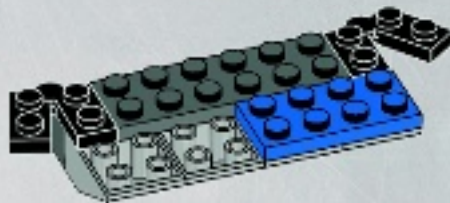



5

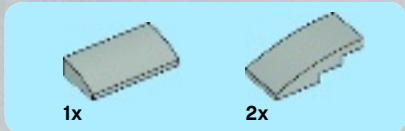
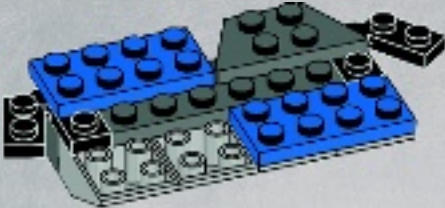

6

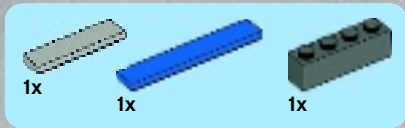
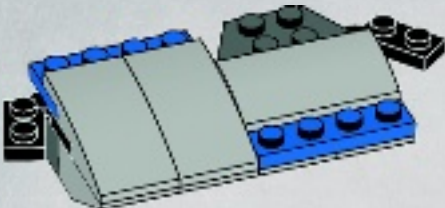

7

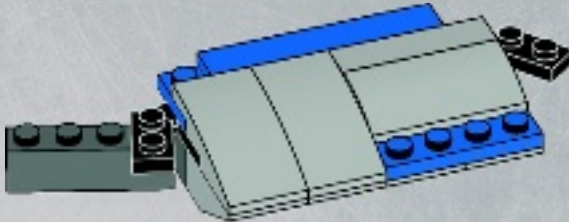

8

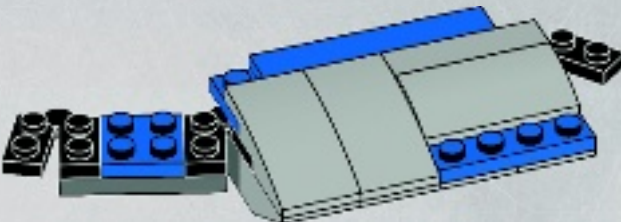



2x

9

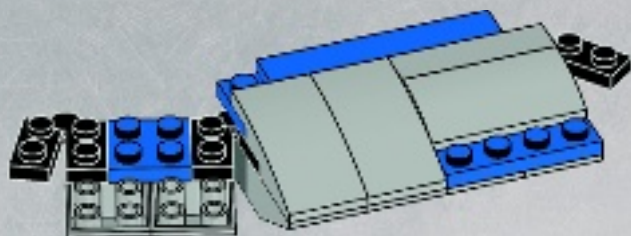

1x

10

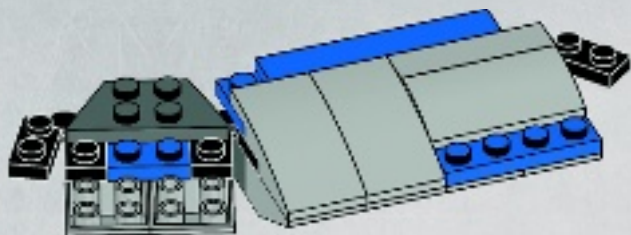

2x

11

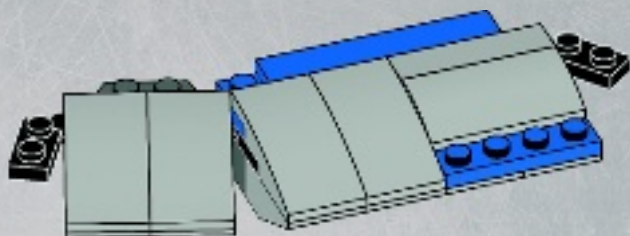

1x



1x

12

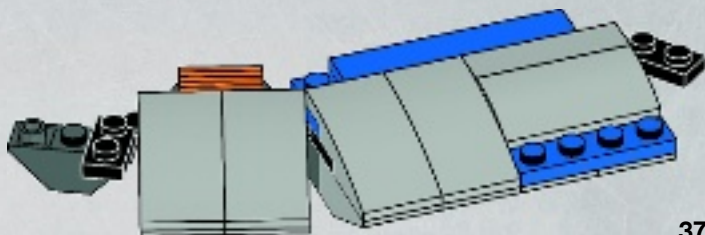



1x

# 13

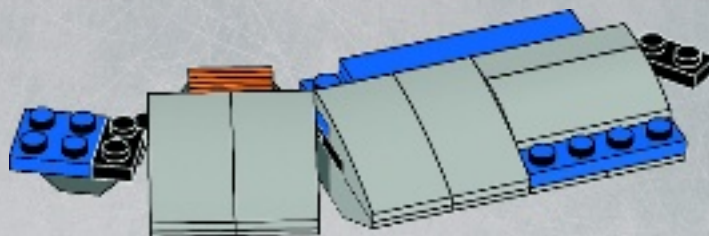

2x

# 14

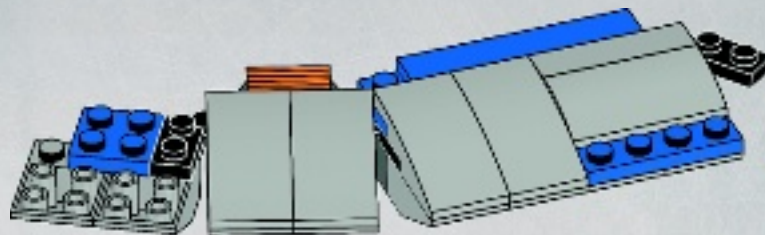



1x

15

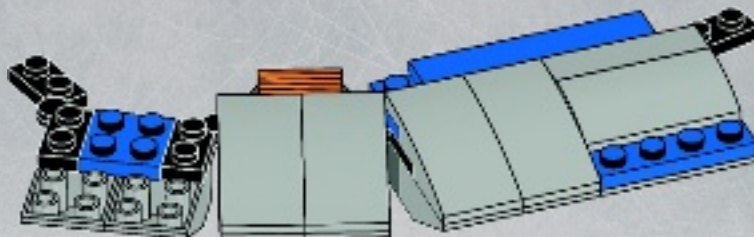

1x

16

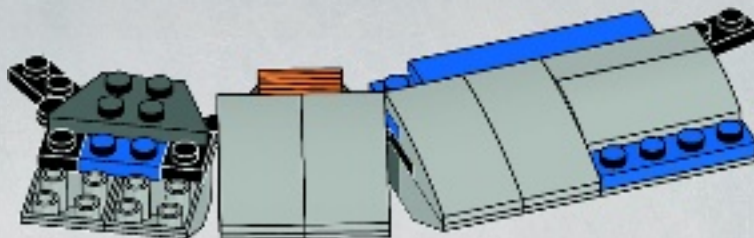

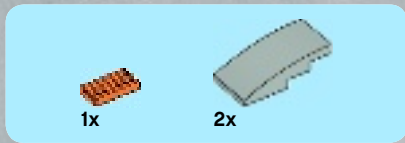

17

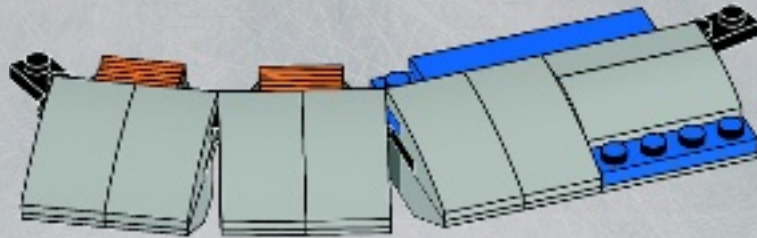

21

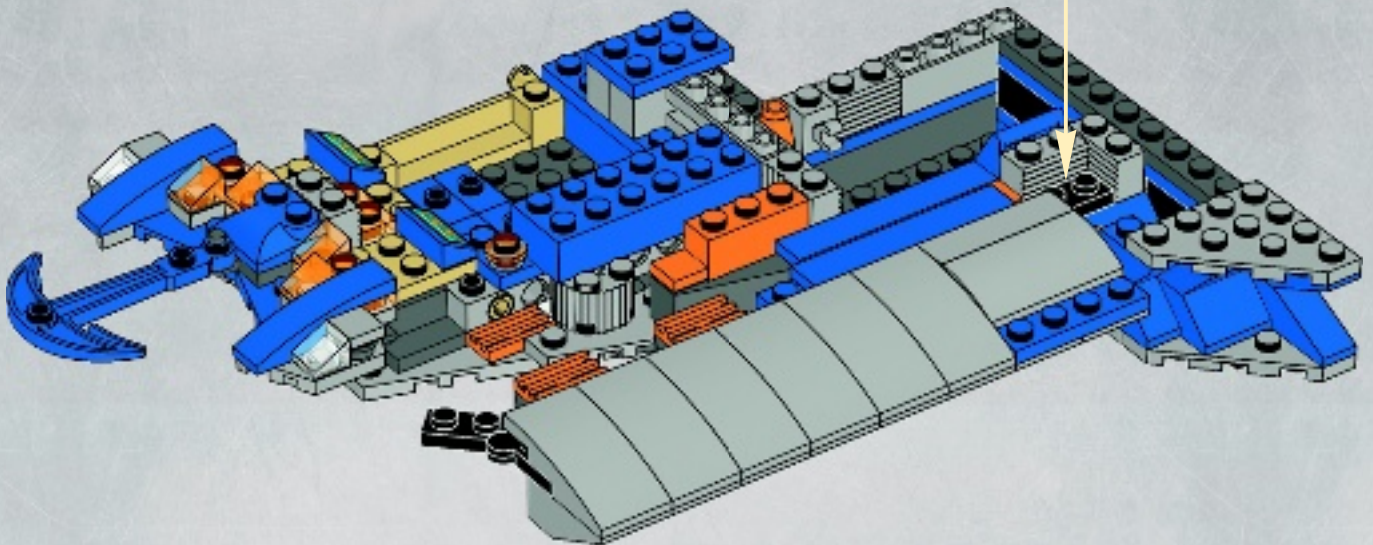





22

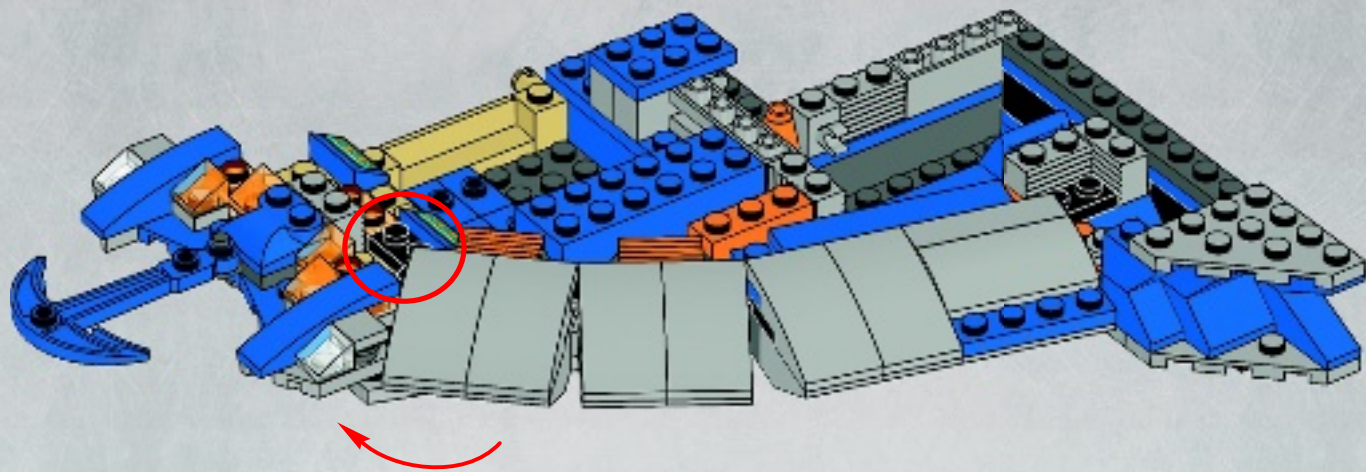



1x



1x

# 23

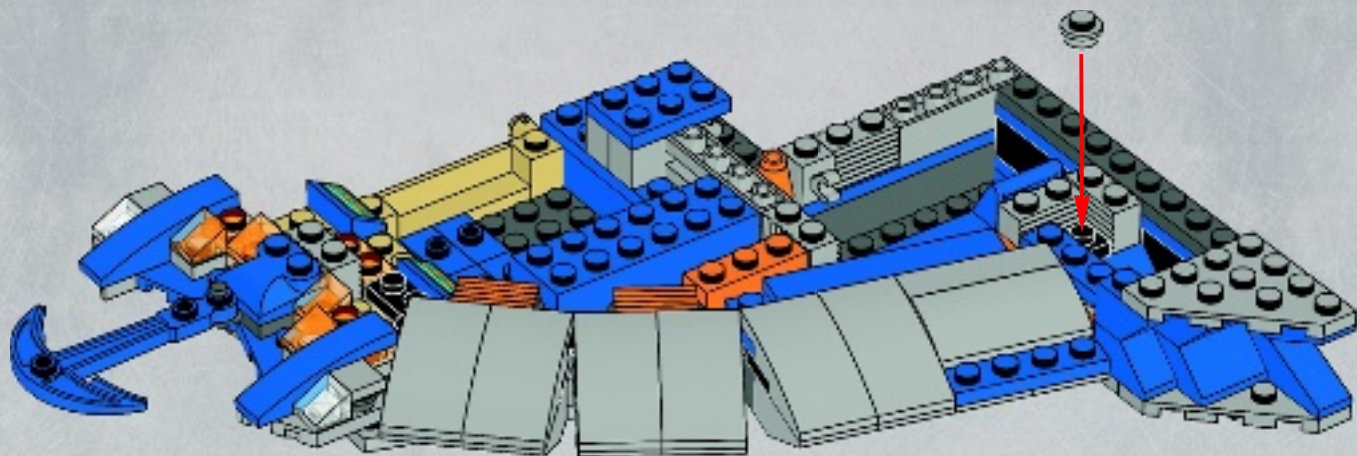



2x

24

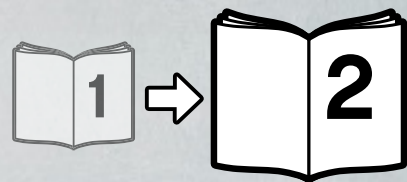
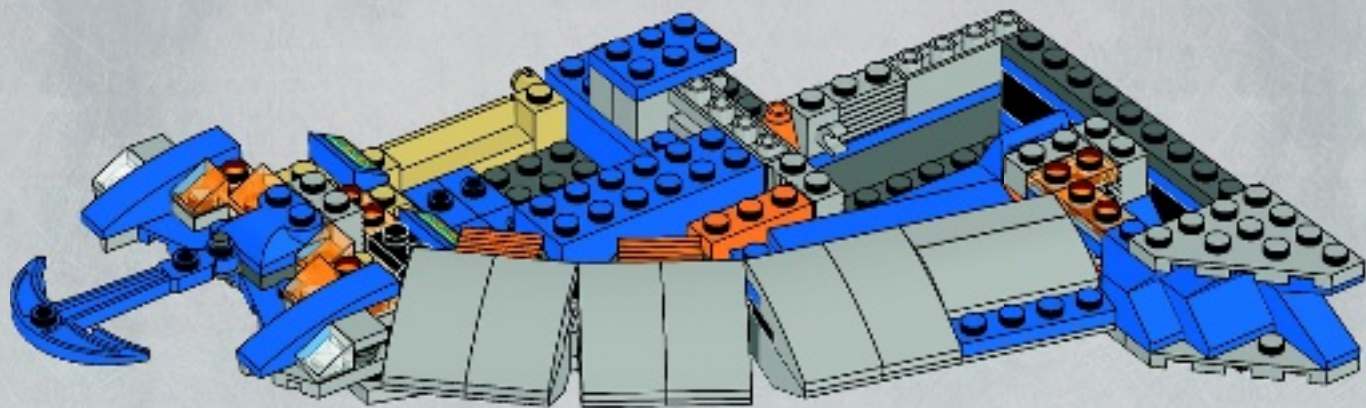

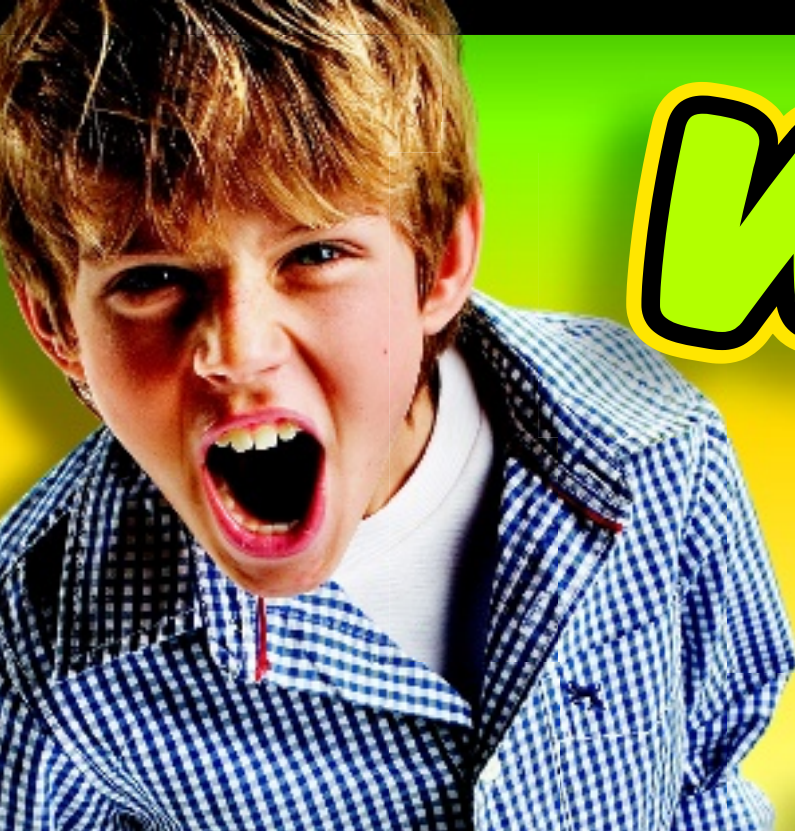

# WIN!

Go to [www.LEGOsurvey.com/product](http://www.LEGOsurvey.com/product)  
to fill out a survey for a chance  
to win a cool LEGO® Product.  
No purchase necessary.  
Open to all residents where not prohibited.



## [www.LEGOsurvey.com/product](http://www.LEGOsurvey.com/product)

### GEWINNE! WIN!

Nimm an der Umfrage auf  
[www.LEGOsurvey.com/product](http://www.LEGOsurvey.com/product)  
teil und hab die Chance ein cooles  
LEGO® Produkt zu gewinnen!

Die Teilnahme am Gewinnspiel führt zu keinerlei  
Kaufverpflichtungen. Teilnahme in allen nicht  
ausgeschlossenen Ländern möglich.

Ga naar [www.LEGOsurvey.com/product](http://www.LEGOsurvey.com/product),  
vul een  
enquêteformulier in en maak  
kans op een cool LEGO® product.

Geen aankoopverplichting.  
Iedereen mag deelnemen, uitgezonderd  
ingezetenden van landen waar een  
enquêteverbod geldt.

### GAGNE! 当てよう!

Visite [www.LEGOsurvey.com/product](http://www.LEGOsurvey.com/product)  
pour répondre à un  
questionnaire et avoir une chance de  
gagner un produit LEGO® très cool!

Aucune obligation d'achat.  
Ouvert à tous les résidents des pays  
autorisés.

[www.LEGOsurvey.com/product](http://www.LEGOsurvey.com/product) にアクセスして、  
アンケートにご記入ください。当選者にはレゴ®  
製品を差し上げます。

お買い上げの必要はありません。

禁止されていない限り、すべての皆様にご利用いただけます。



6045439 / 6045440

LEGO and the LEGO logo are trademarks of the/son des marques de commerce de/  
son marcas registradas de LEGO Group. ©2012 The LEGO Group.

© 2012 Lucasfilm Ltd. & TM. All rights reserved/Tous droits réservés/Todos los derechos reservados.



# STAR WARS



9499



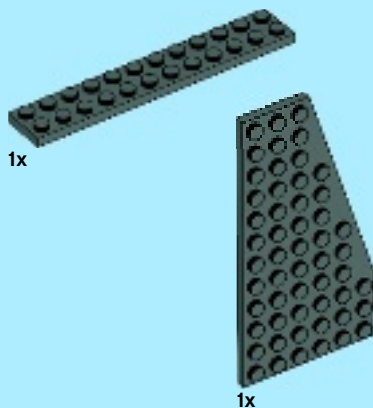
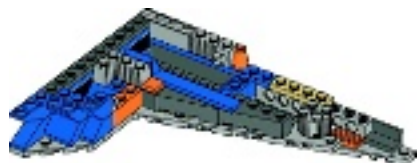

1

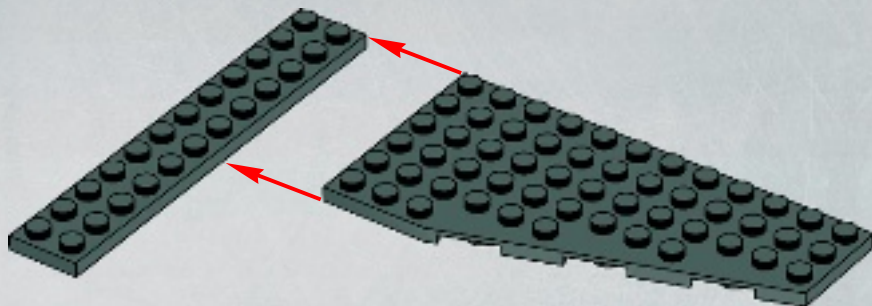

2

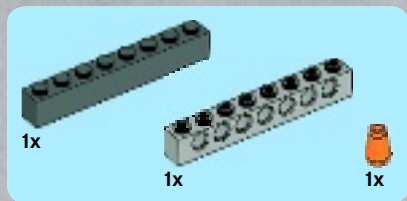

2

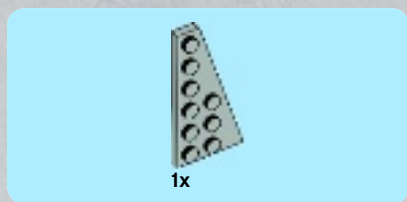
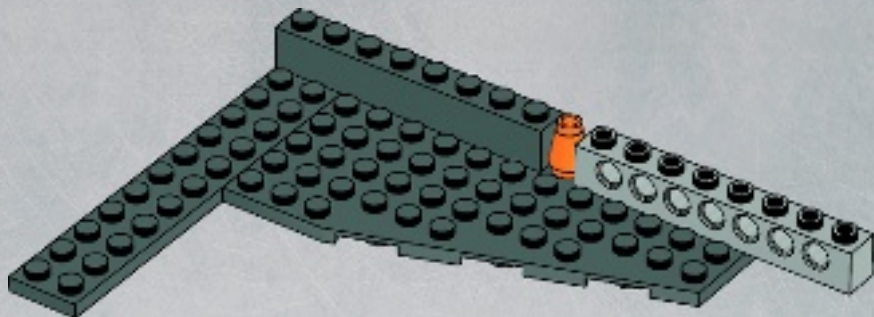

3

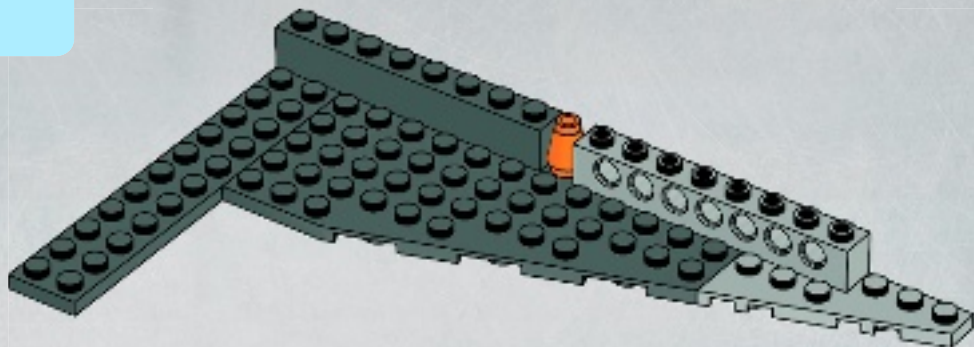



1x



1x



1x

4

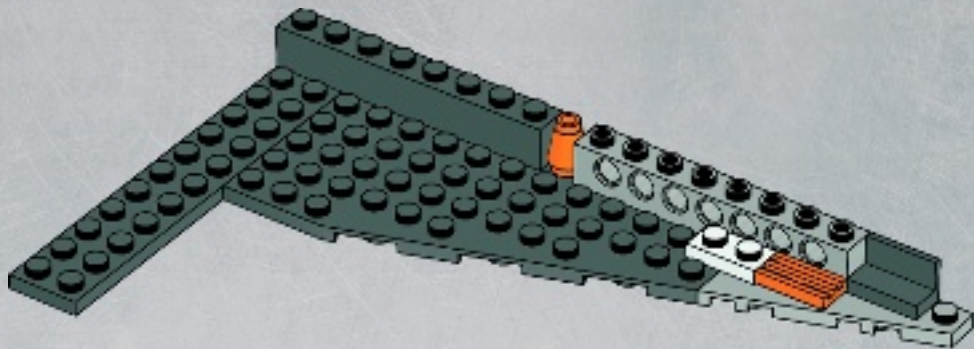

1x



1x

5

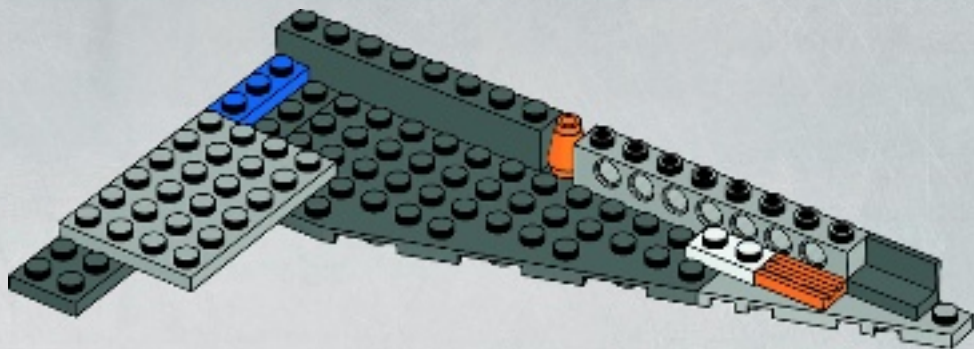

4



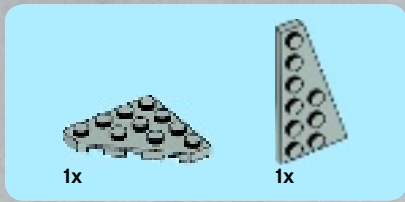

6

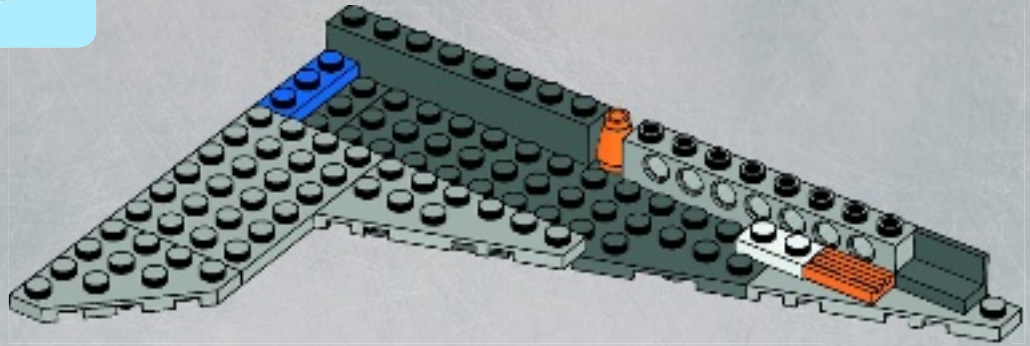

7

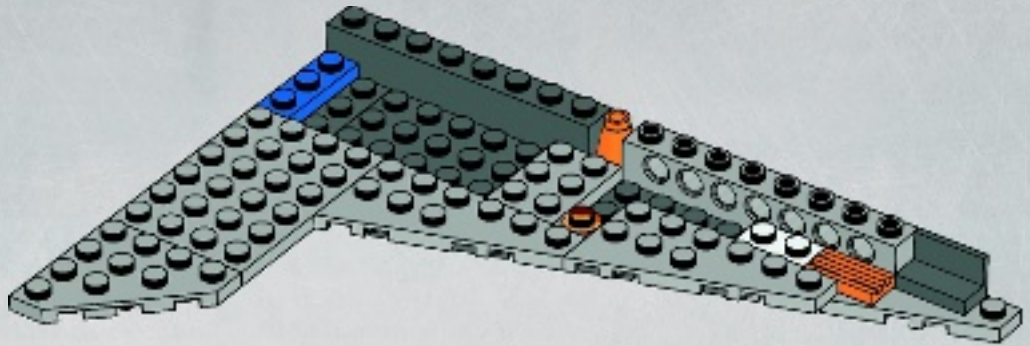

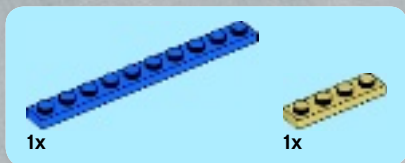

8

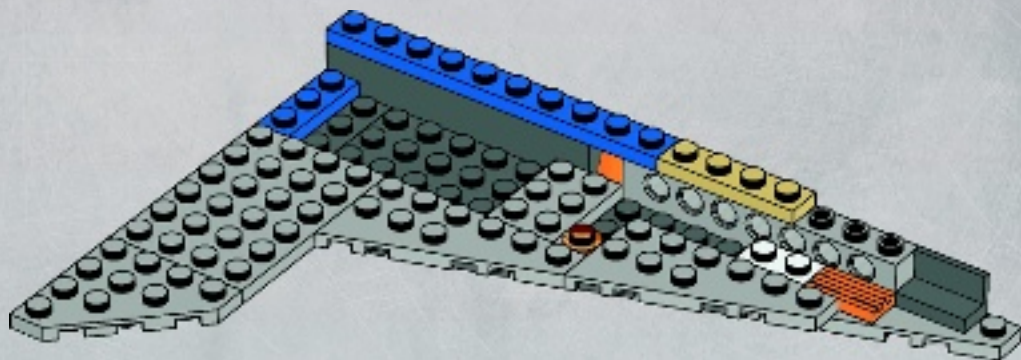

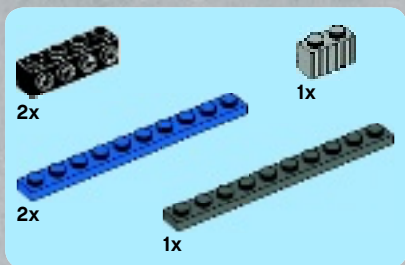

9

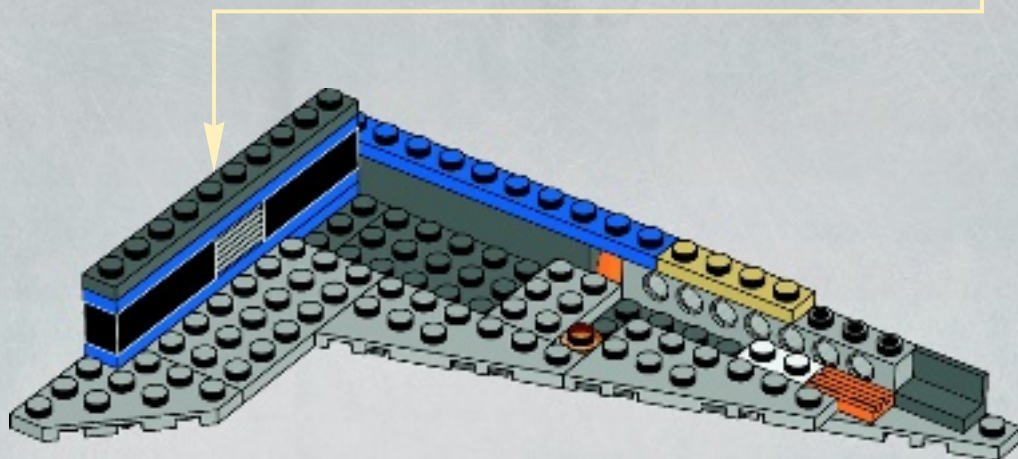
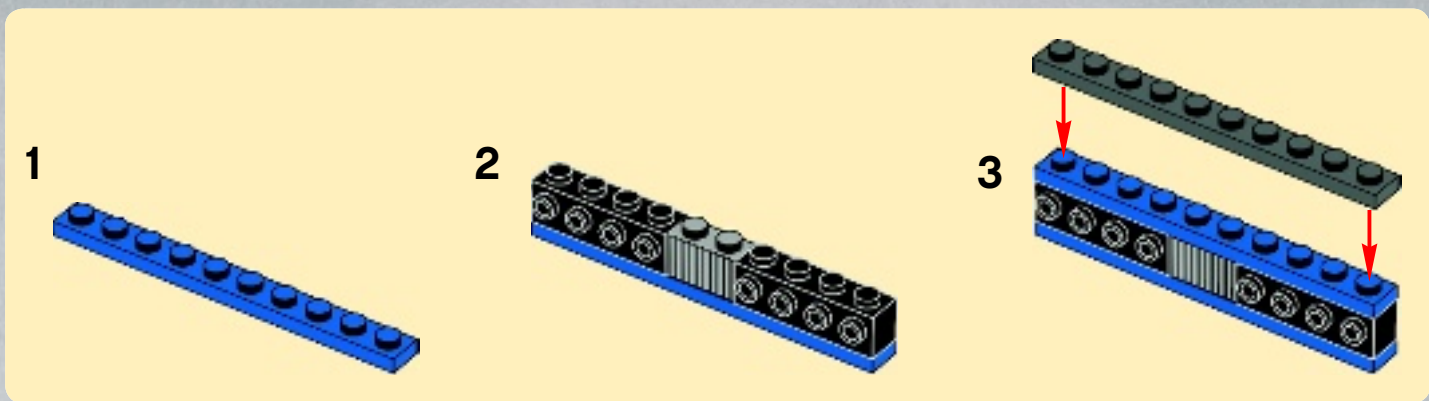



1x



1x



1x

# 10

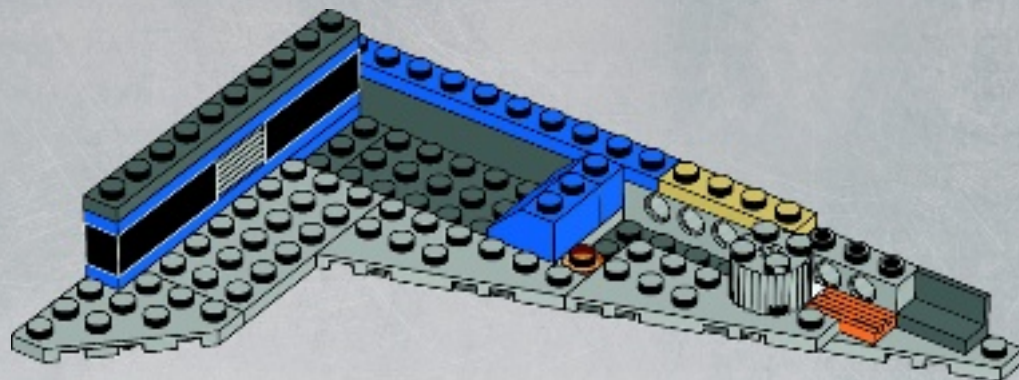

1x



2x

# 11

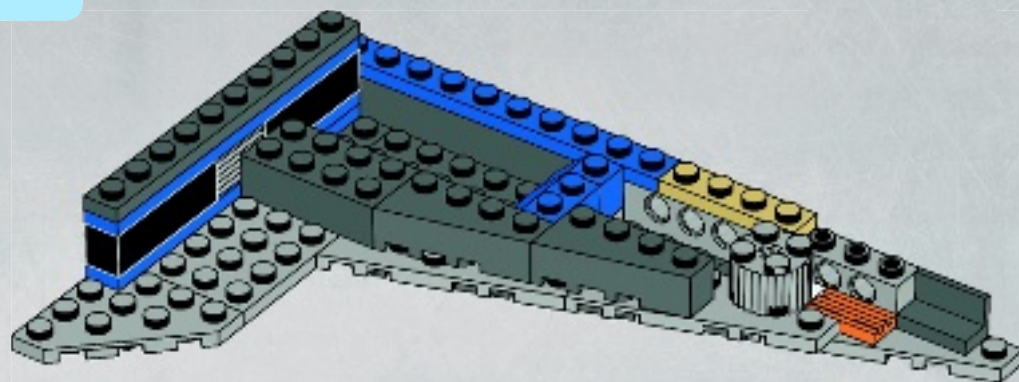



1x



1x

12

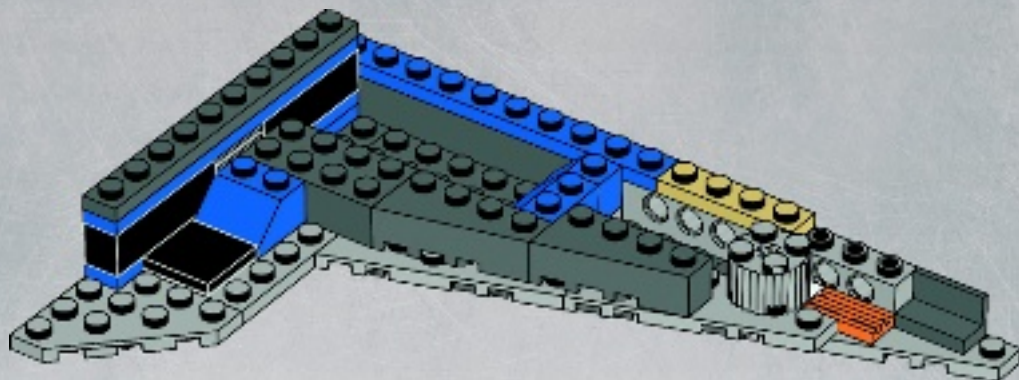

1x



1x



1x



1x

13

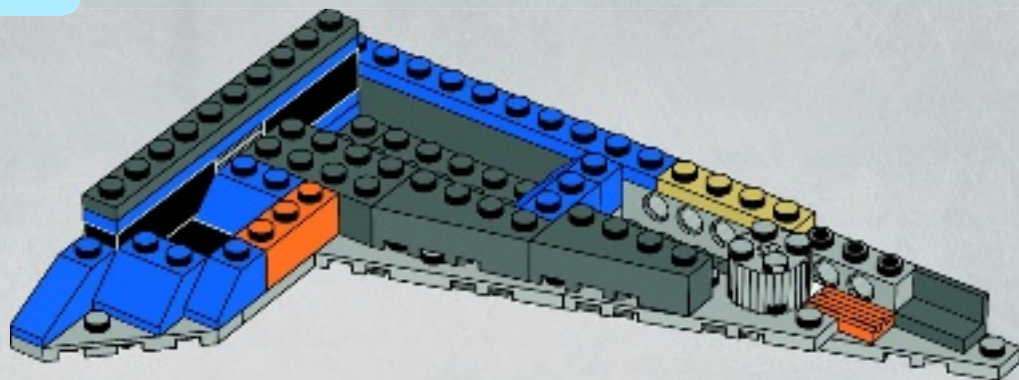

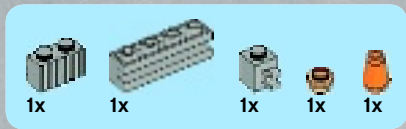

14

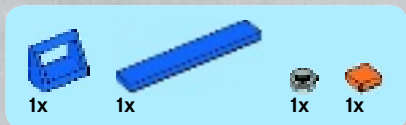
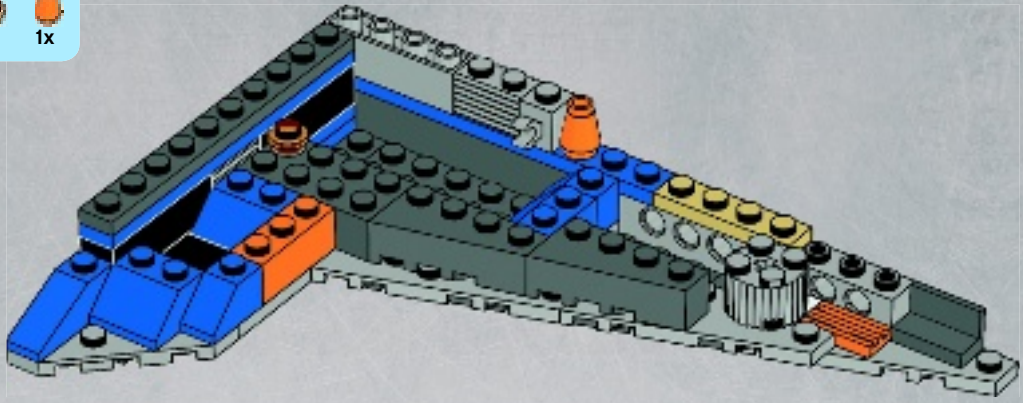

15

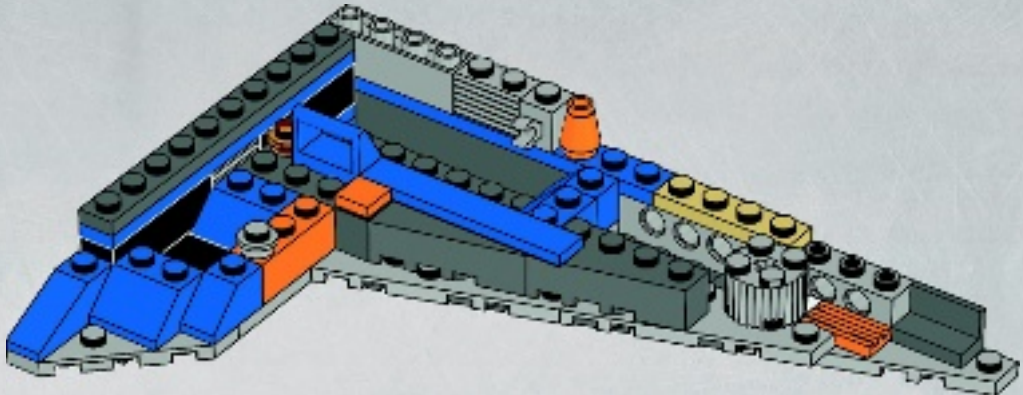



16

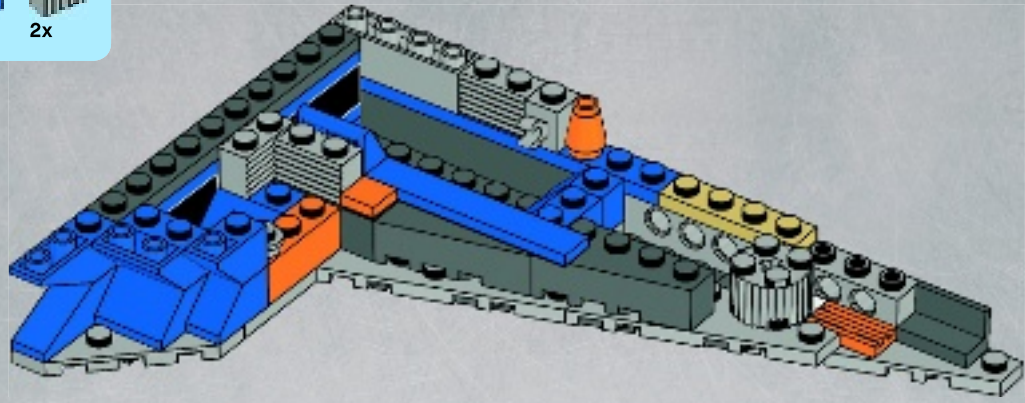

25

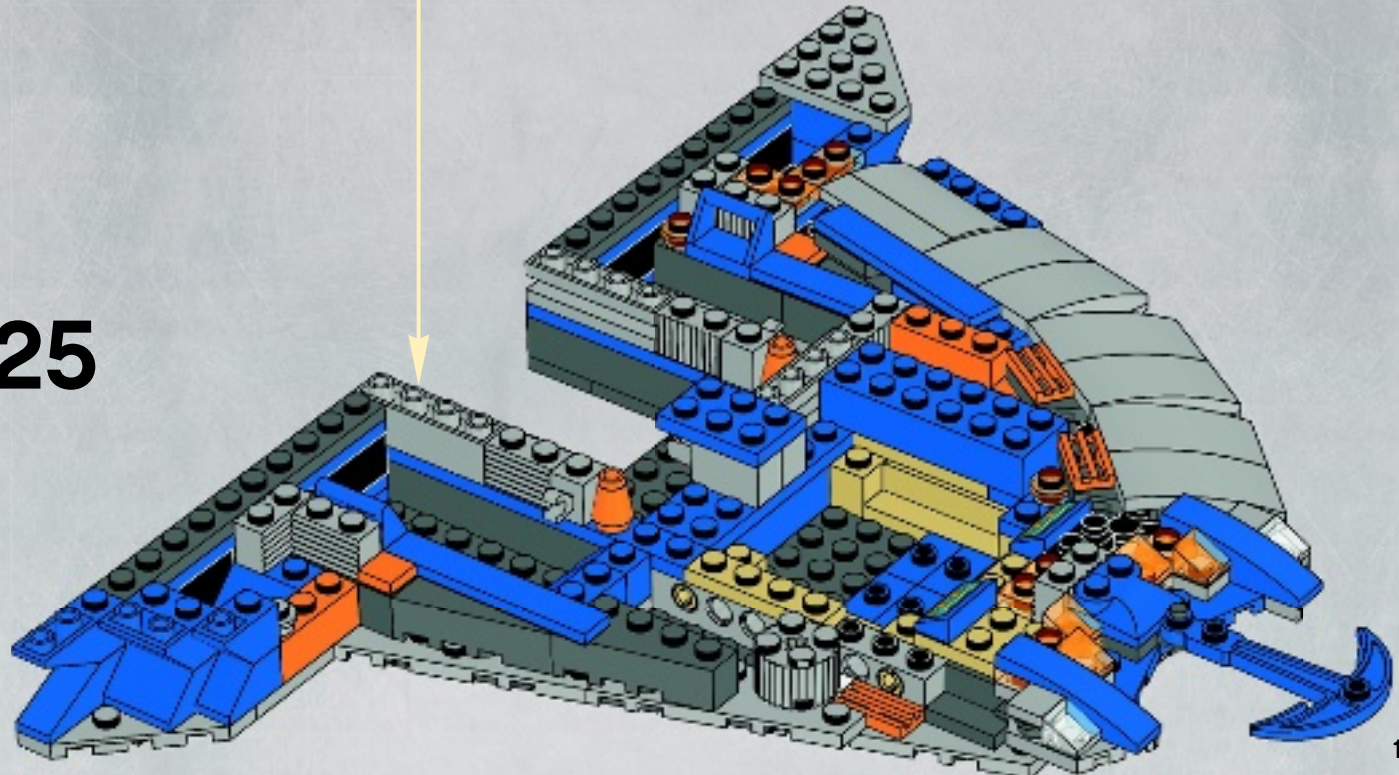



1x



1x

# 26

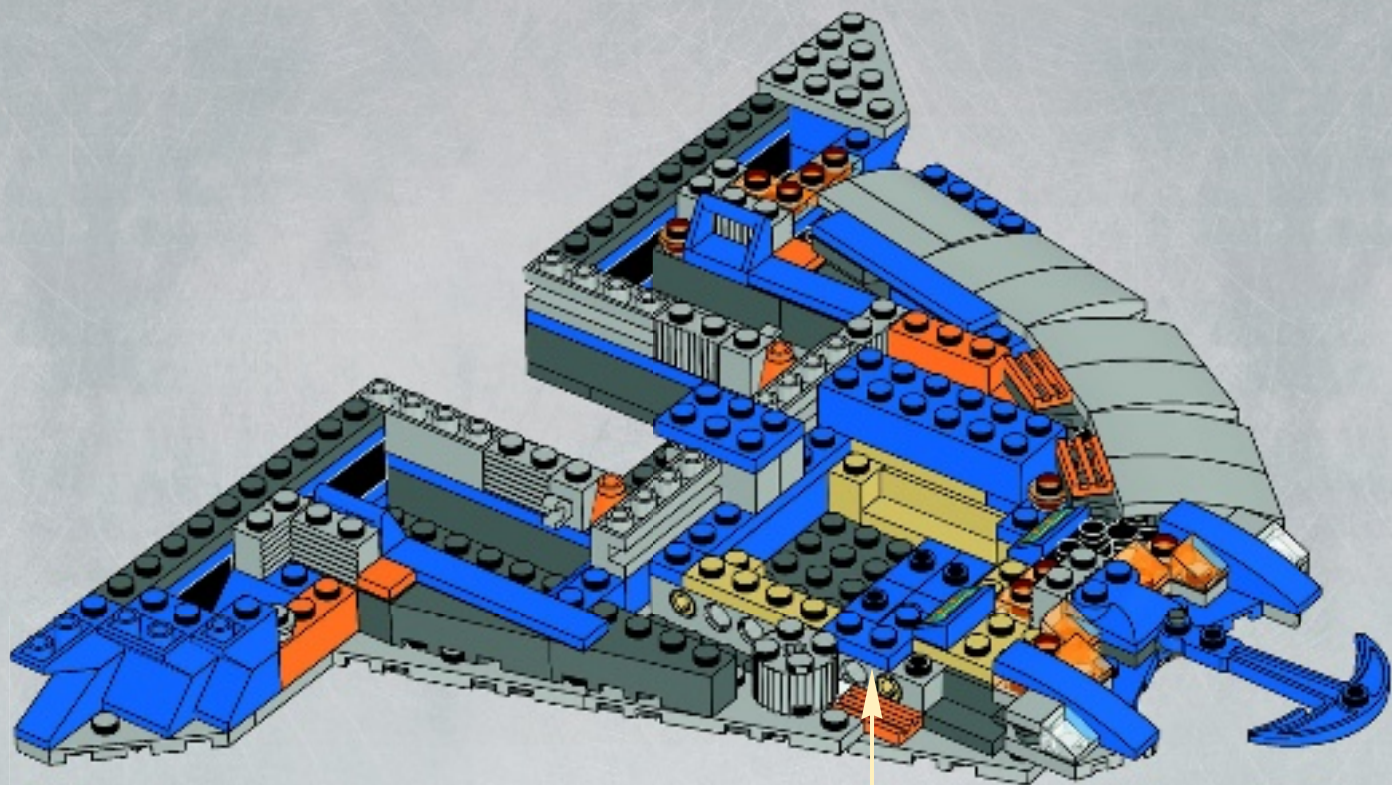



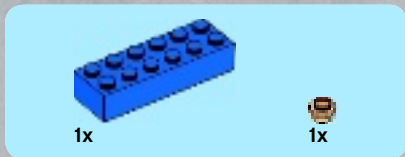

27

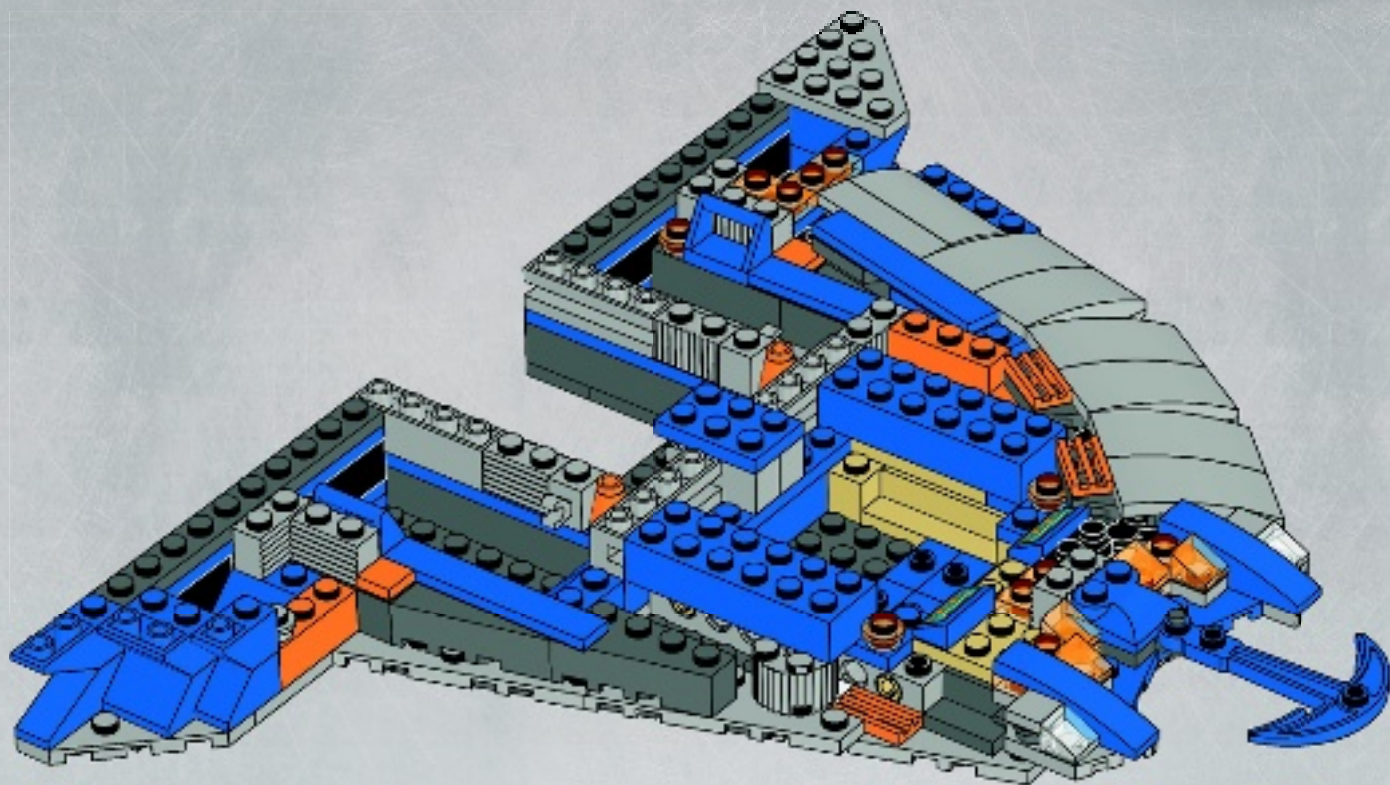



28

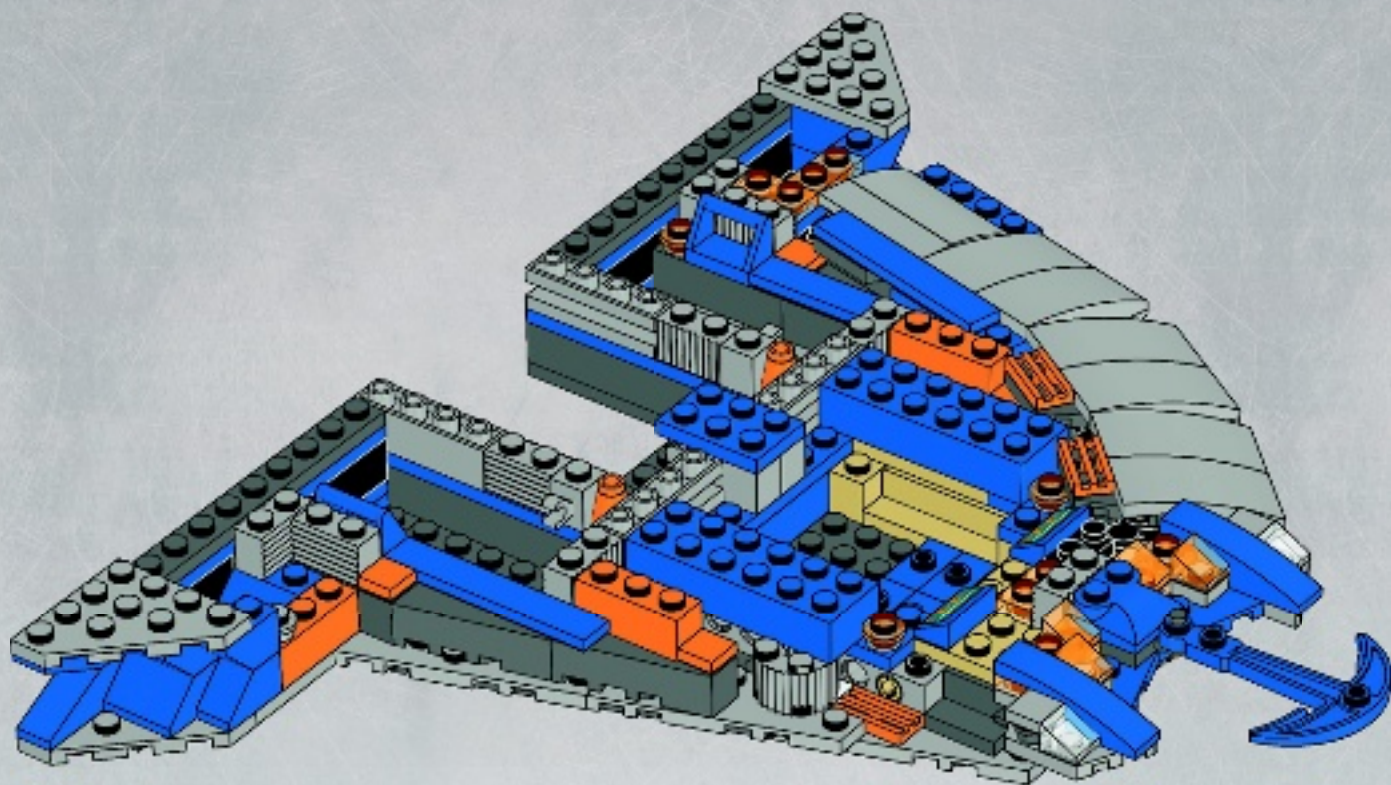

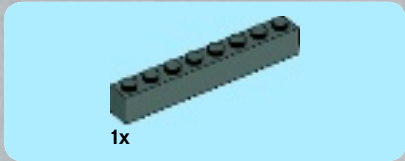
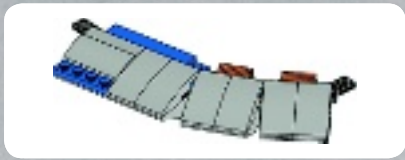

1x

1

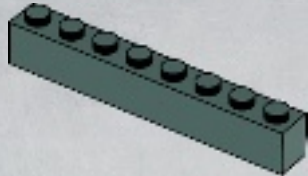

1x

2

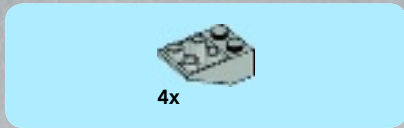

4x

3

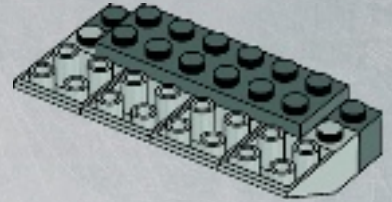

2x

1x

4

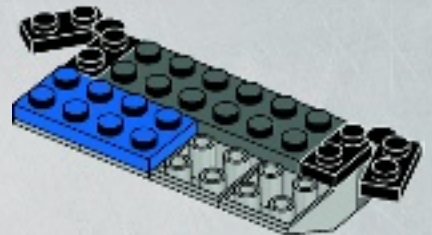



5

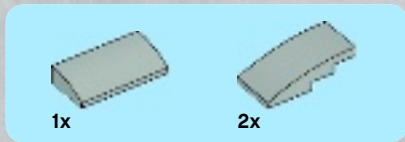
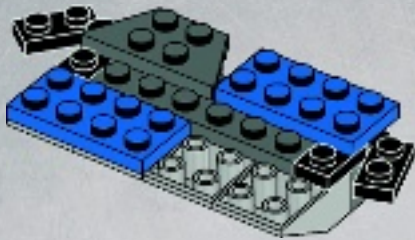

6

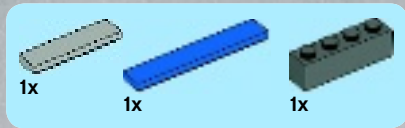
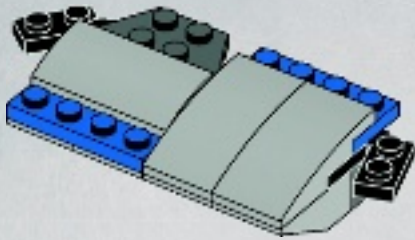

7

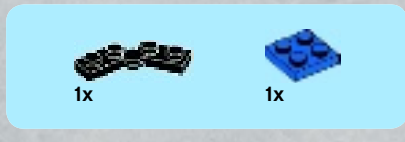
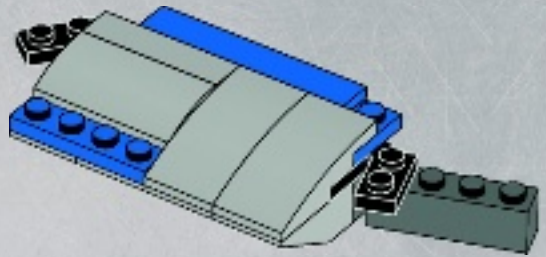

8

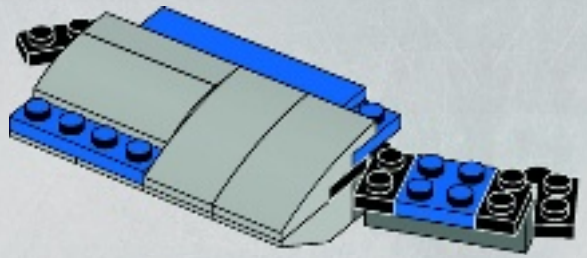



2x

9

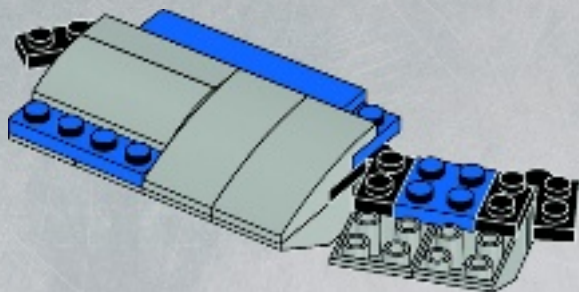

1x

10

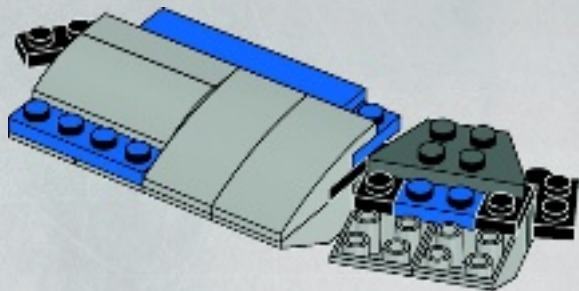

2x

11

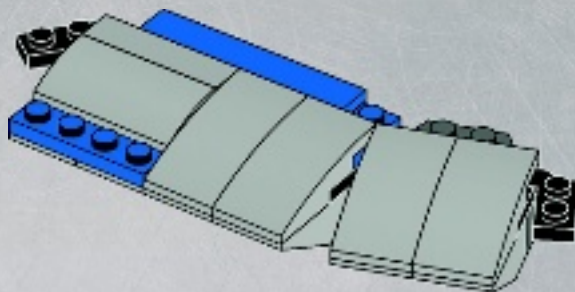

1x



1x

12

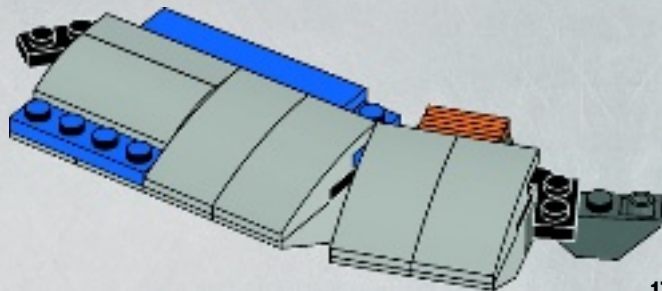



1x

# 13

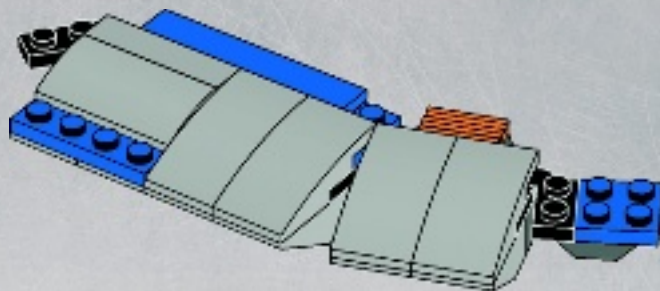

2x

# 14

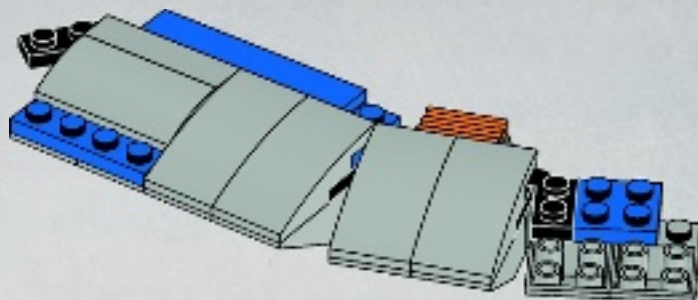



1x

15

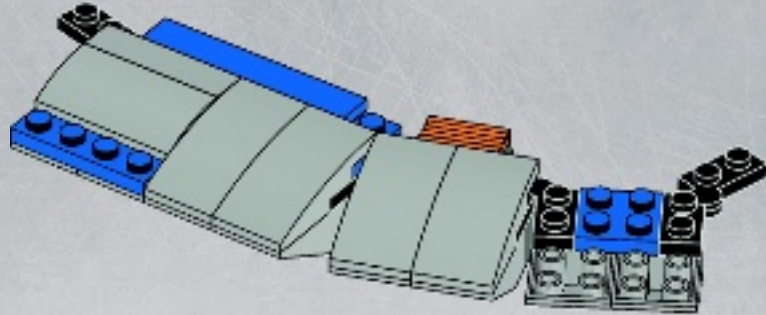

1x

16

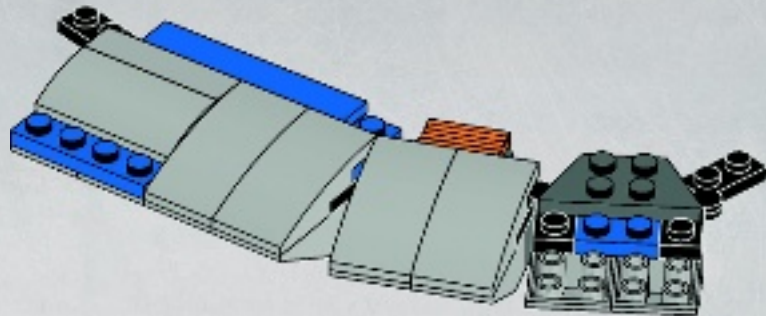



1x



2x

17

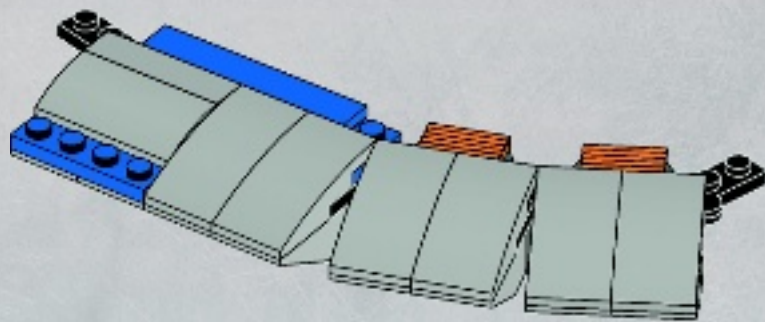



29

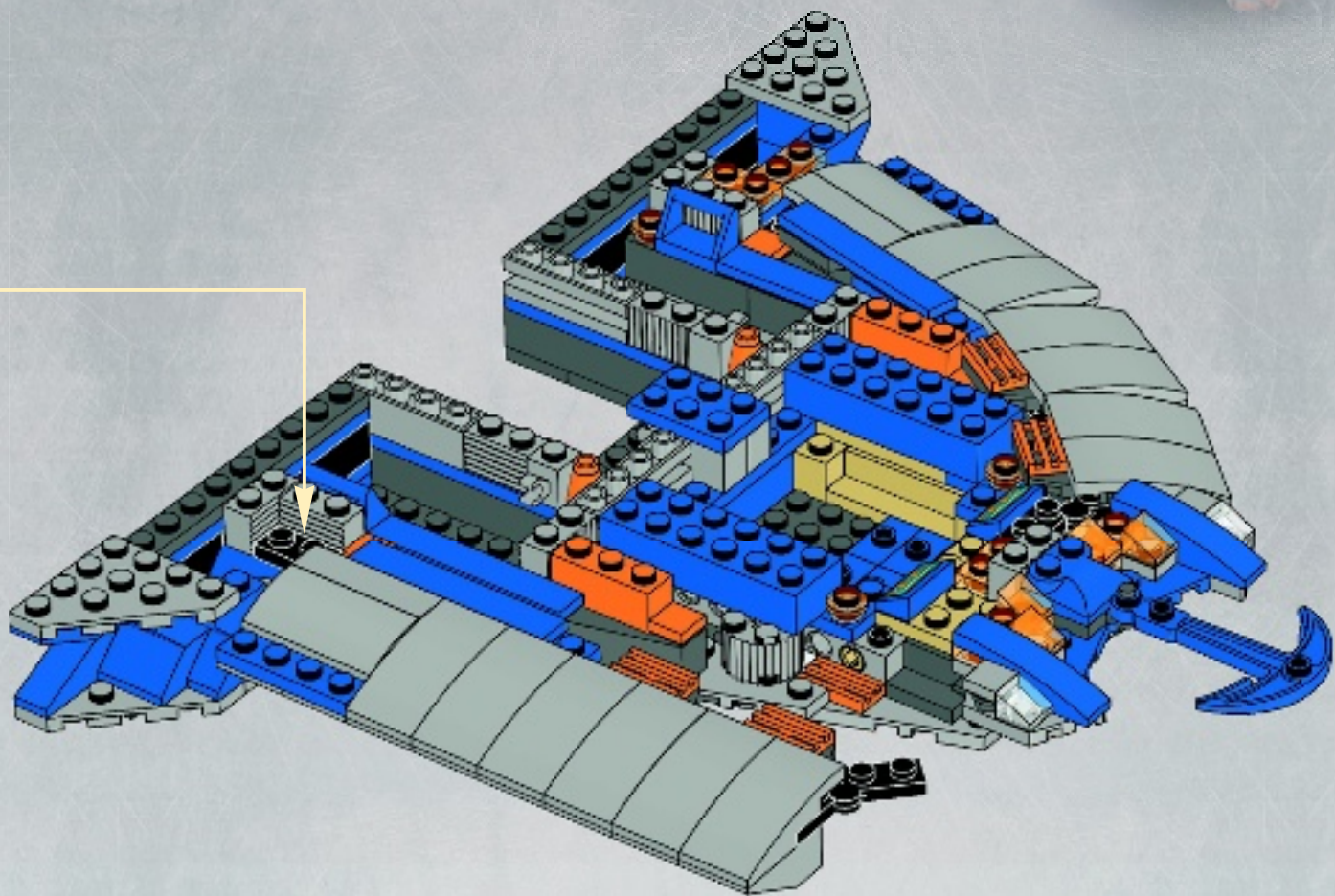

30

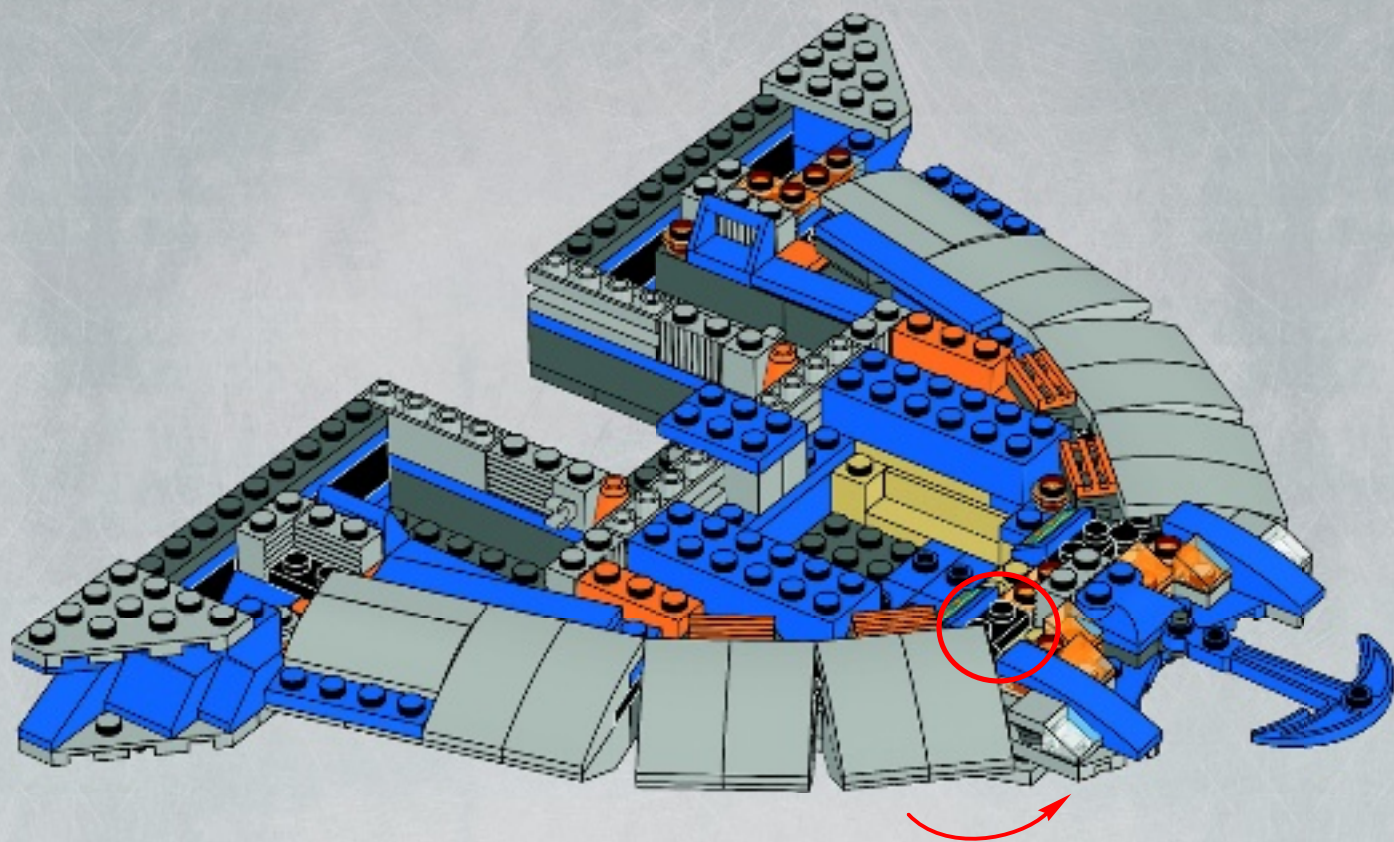



1x



1x

# 31

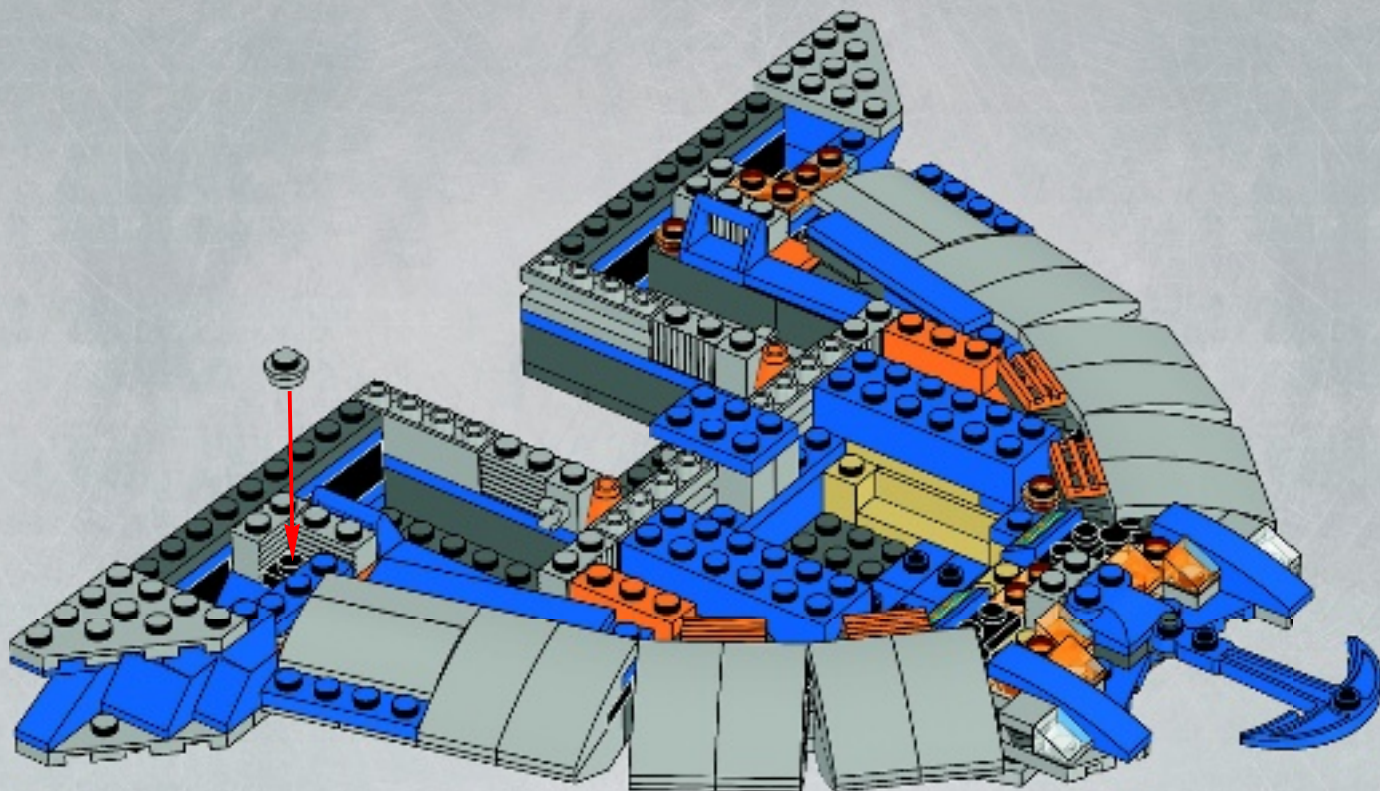



2x

32

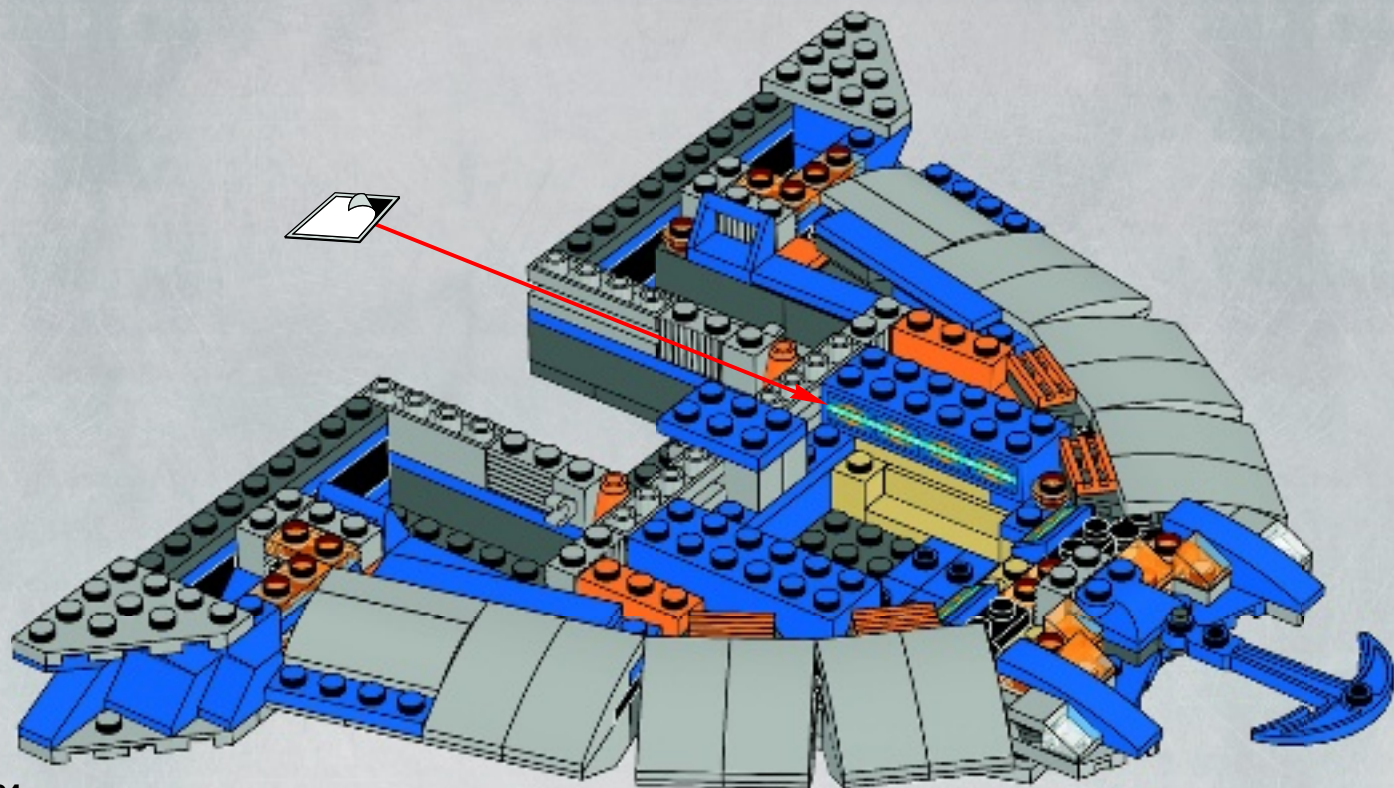

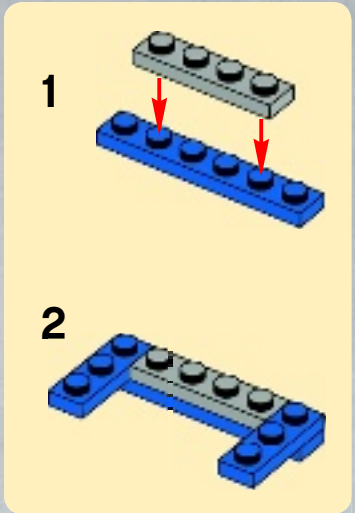
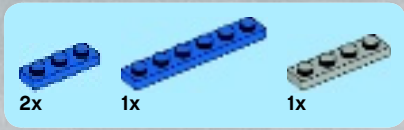
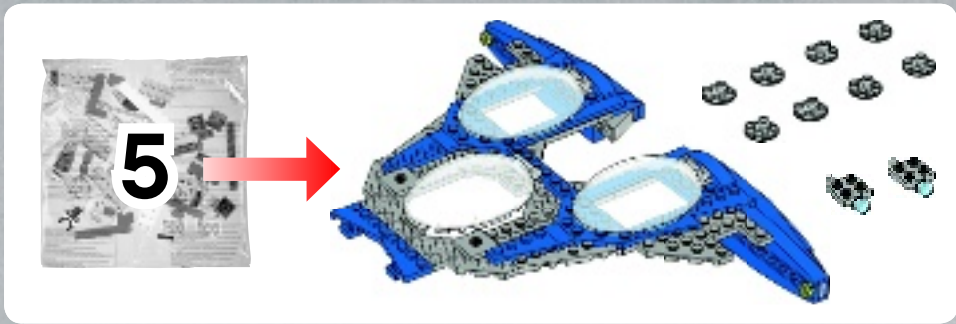

**33**

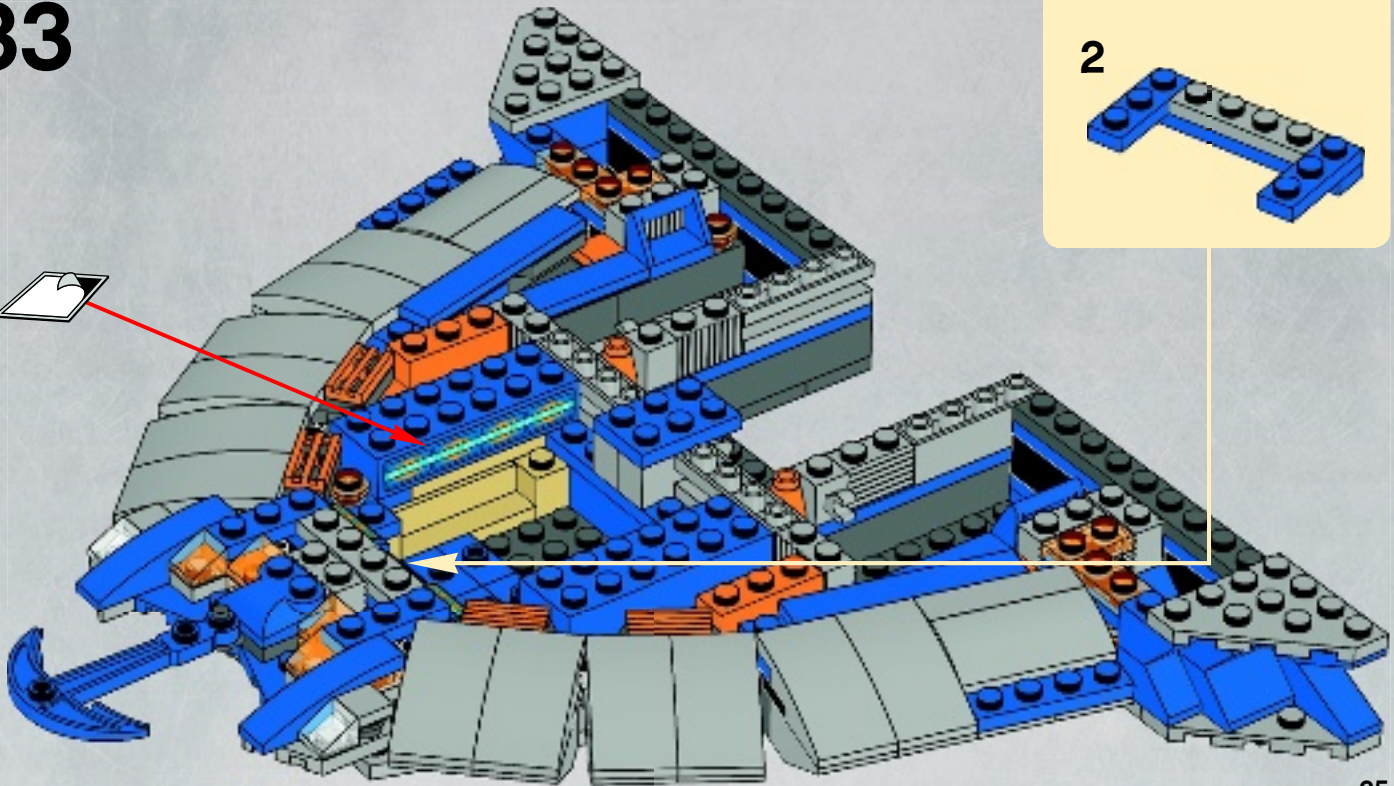



2x



2x



4x

# 34

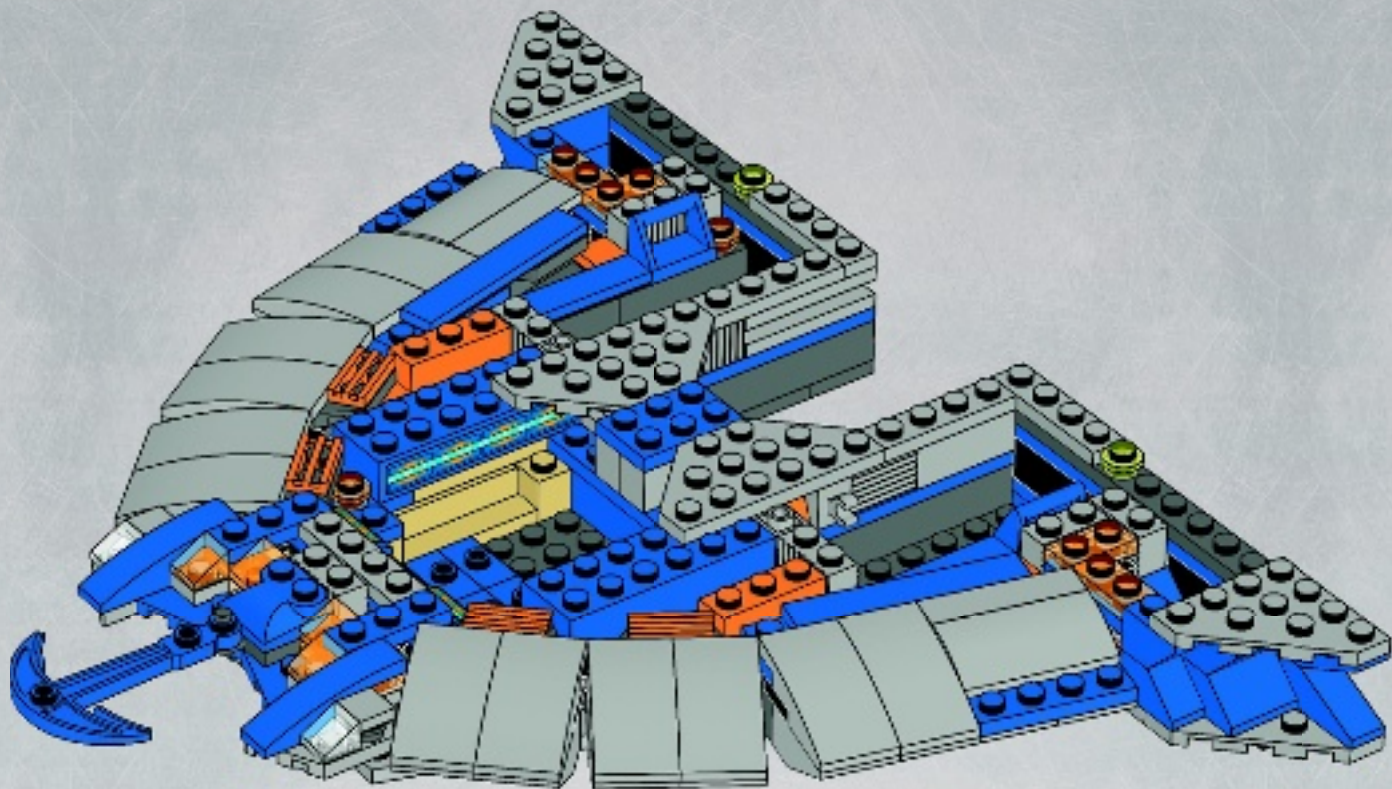

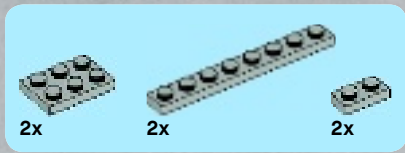

# 35

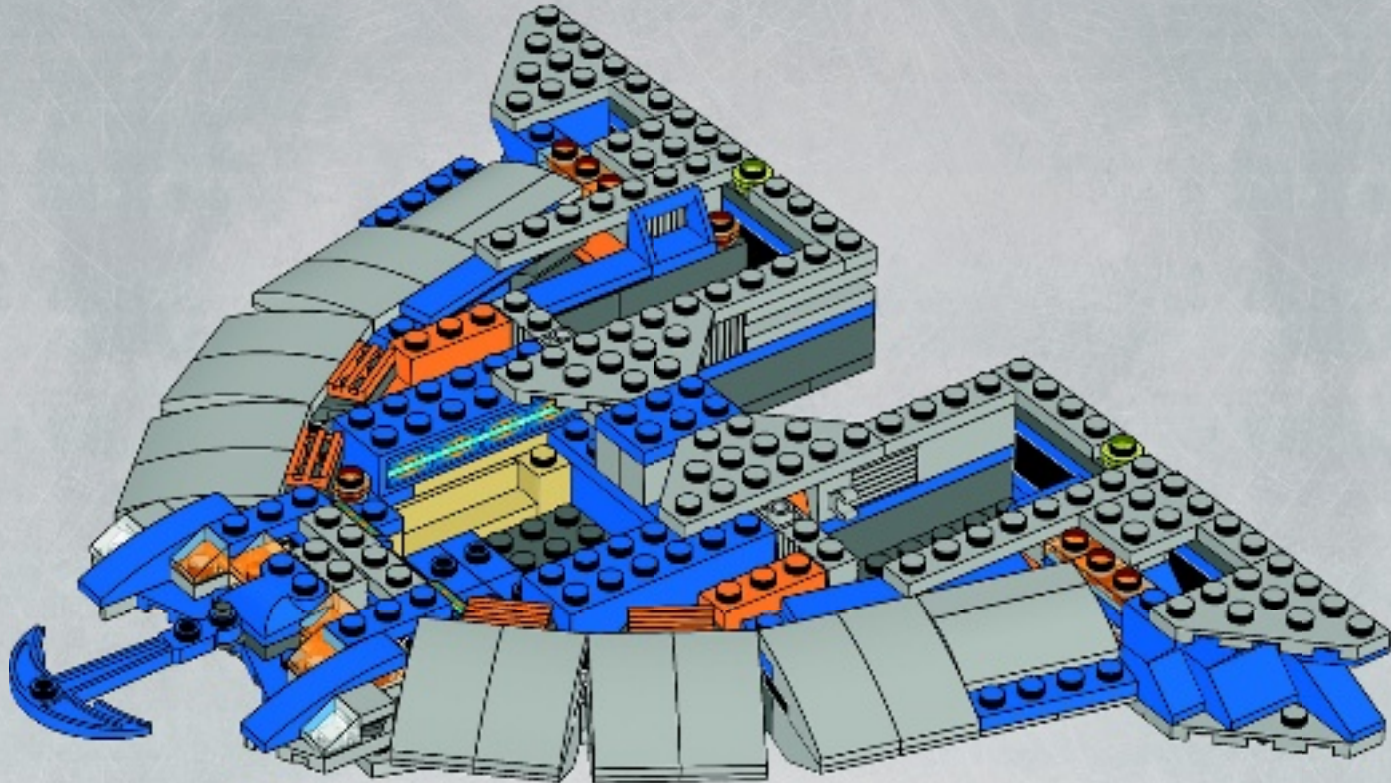

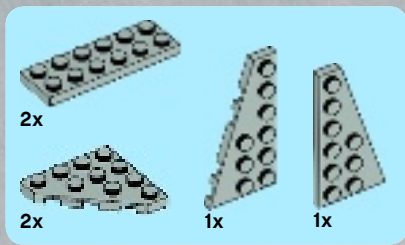

# 36

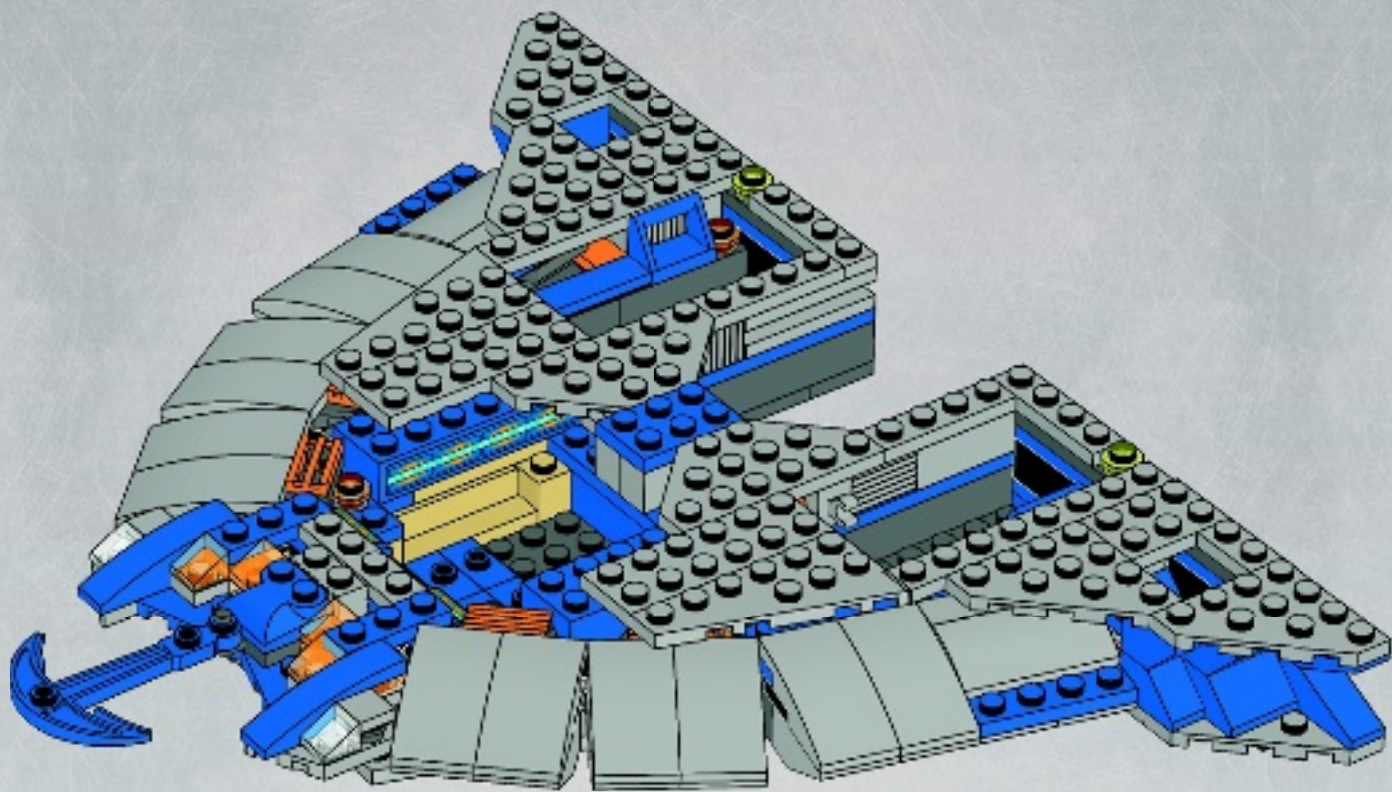





2x



1x

# 37

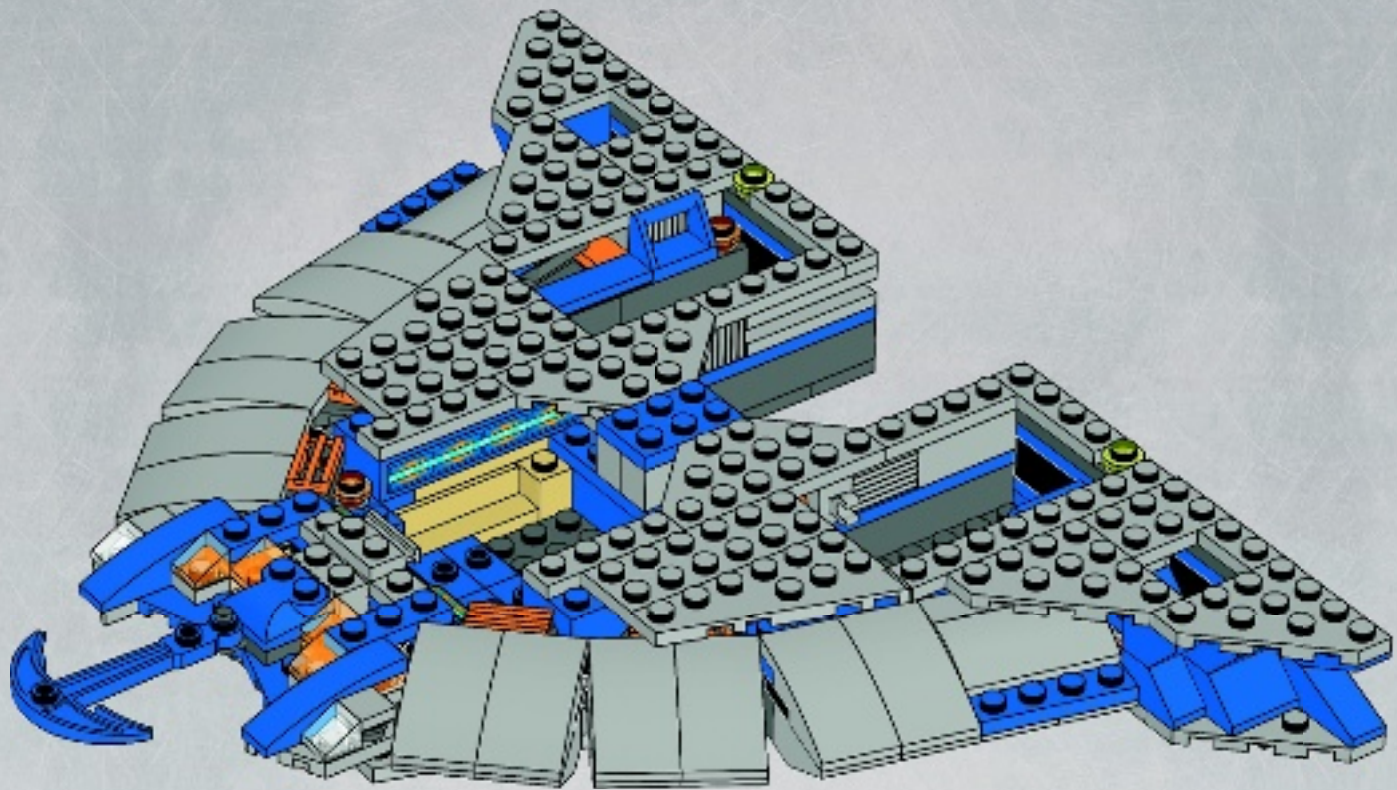



4x

# 38

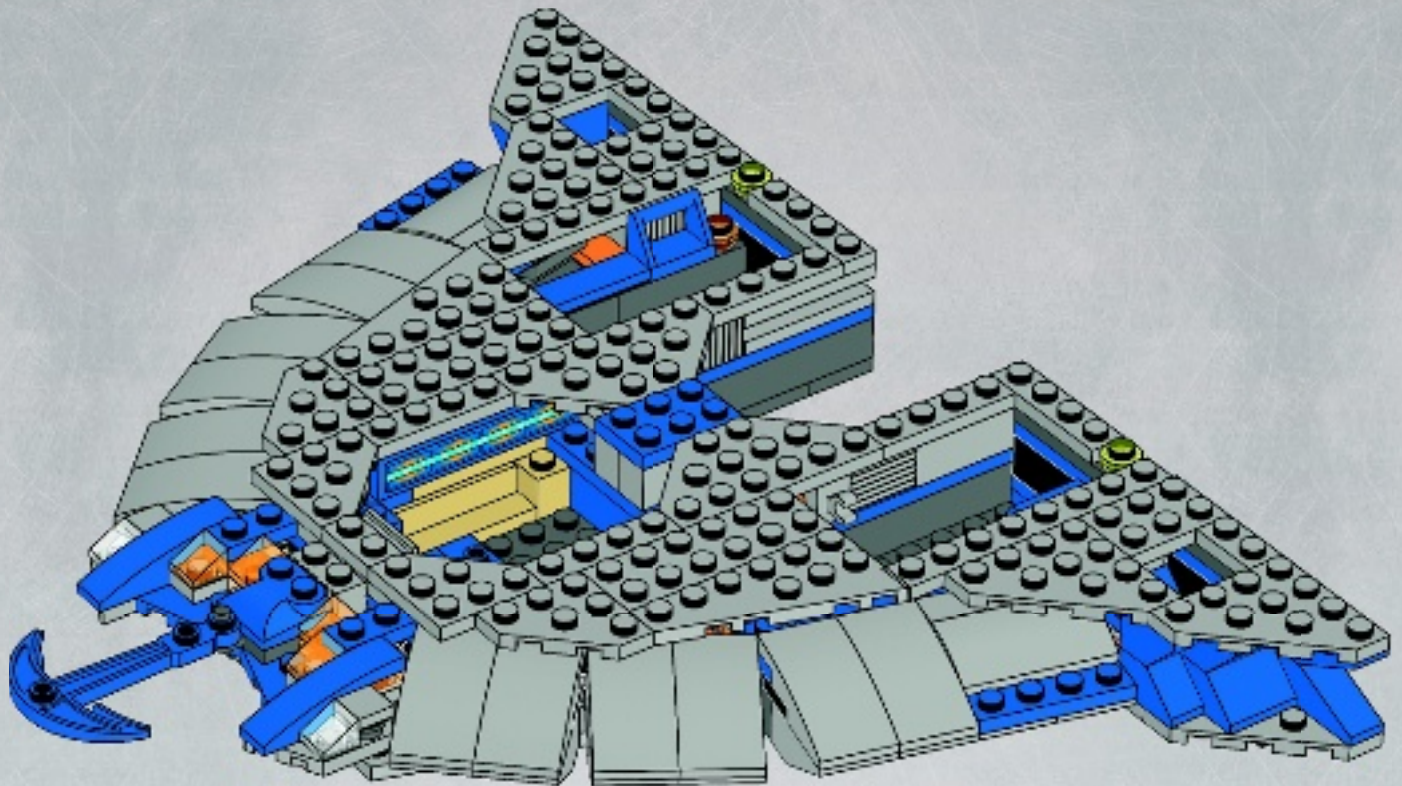

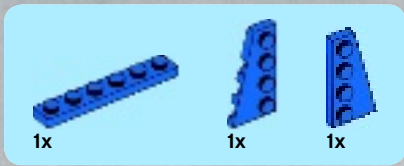

39

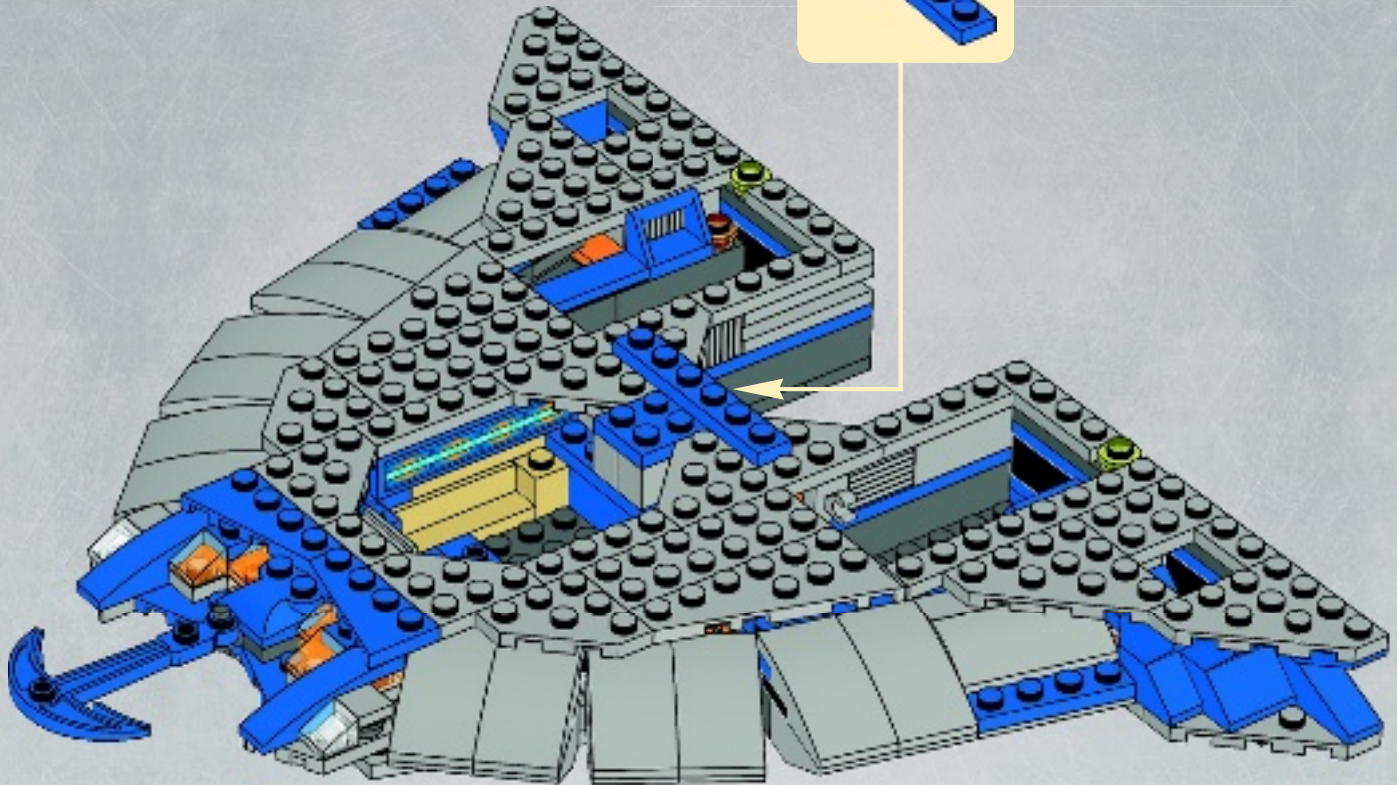
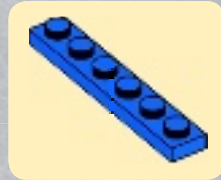

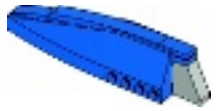

2x



1x

1

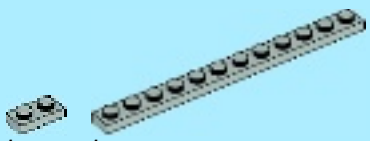
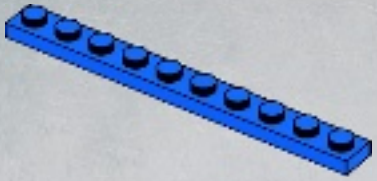

1x

1x

2

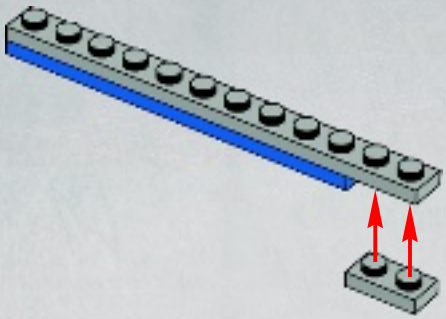

1x



4x



1x

3

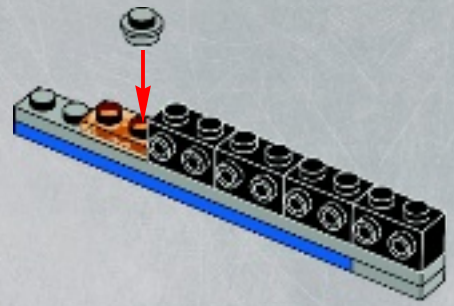

1x



1x

4

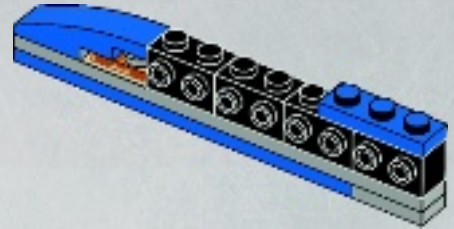

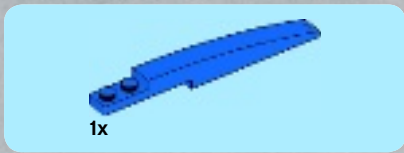

5

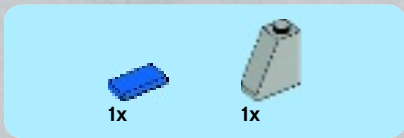
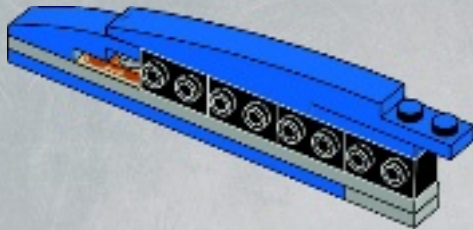

6

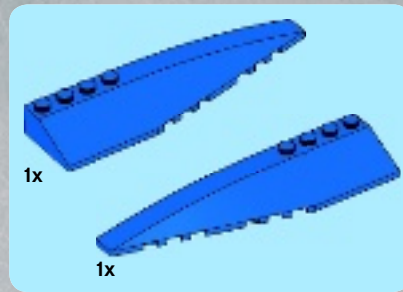
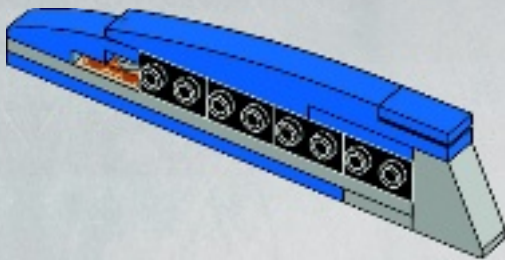

7

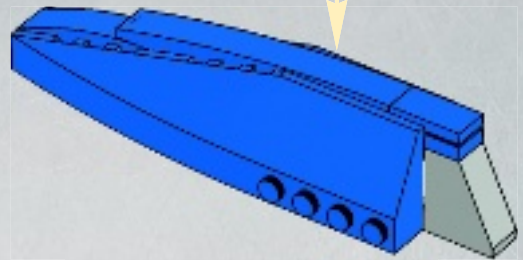
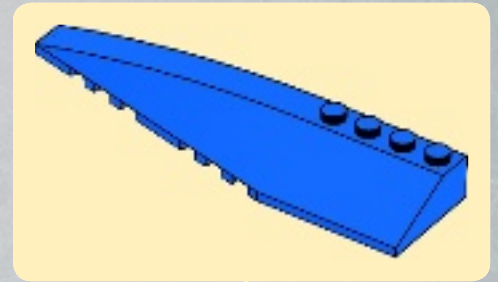



1x

8

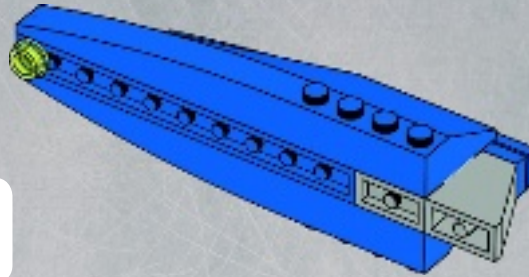

2x

40

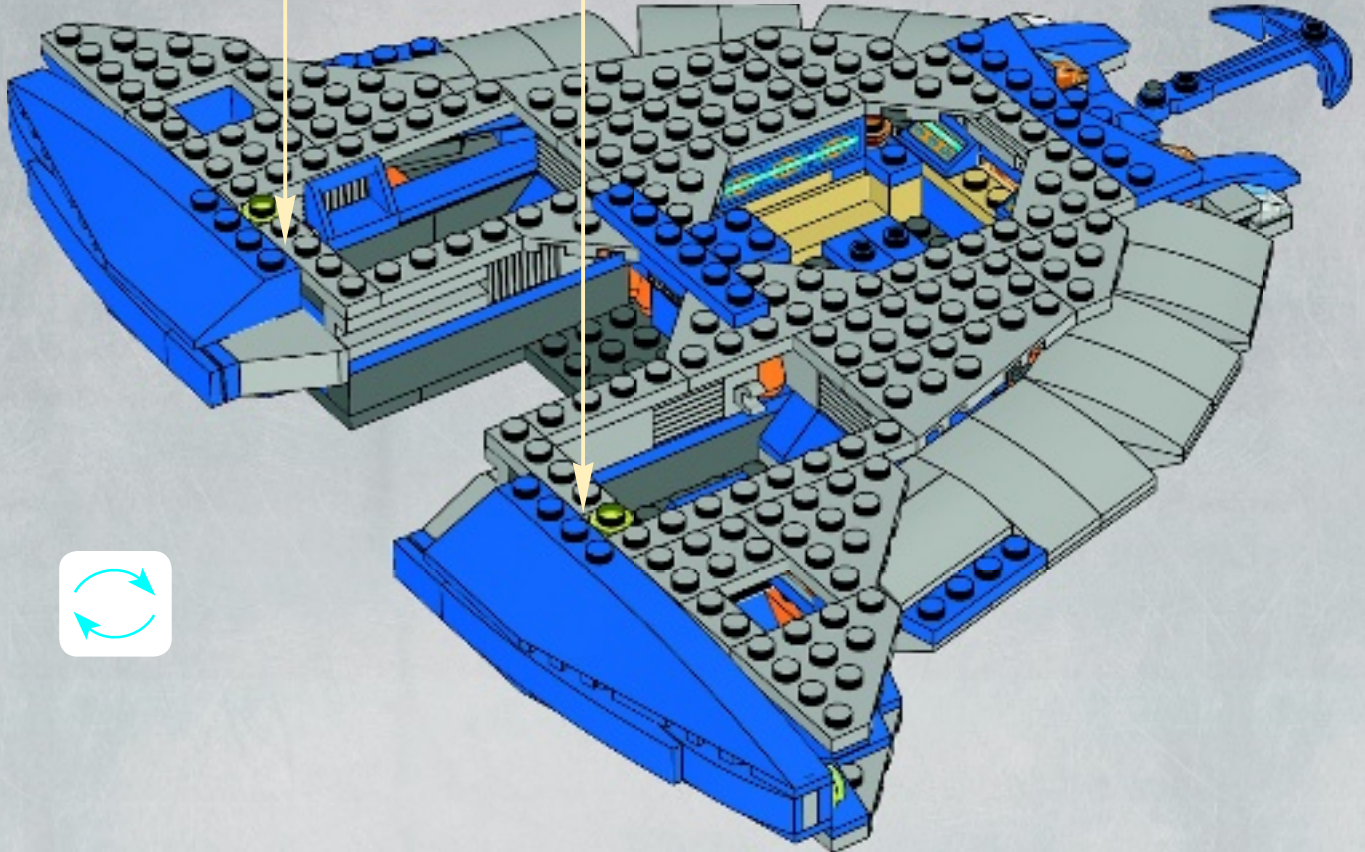

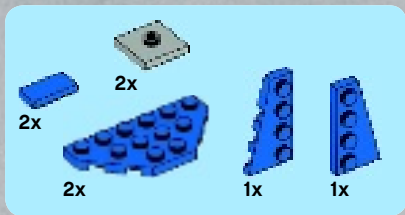

41

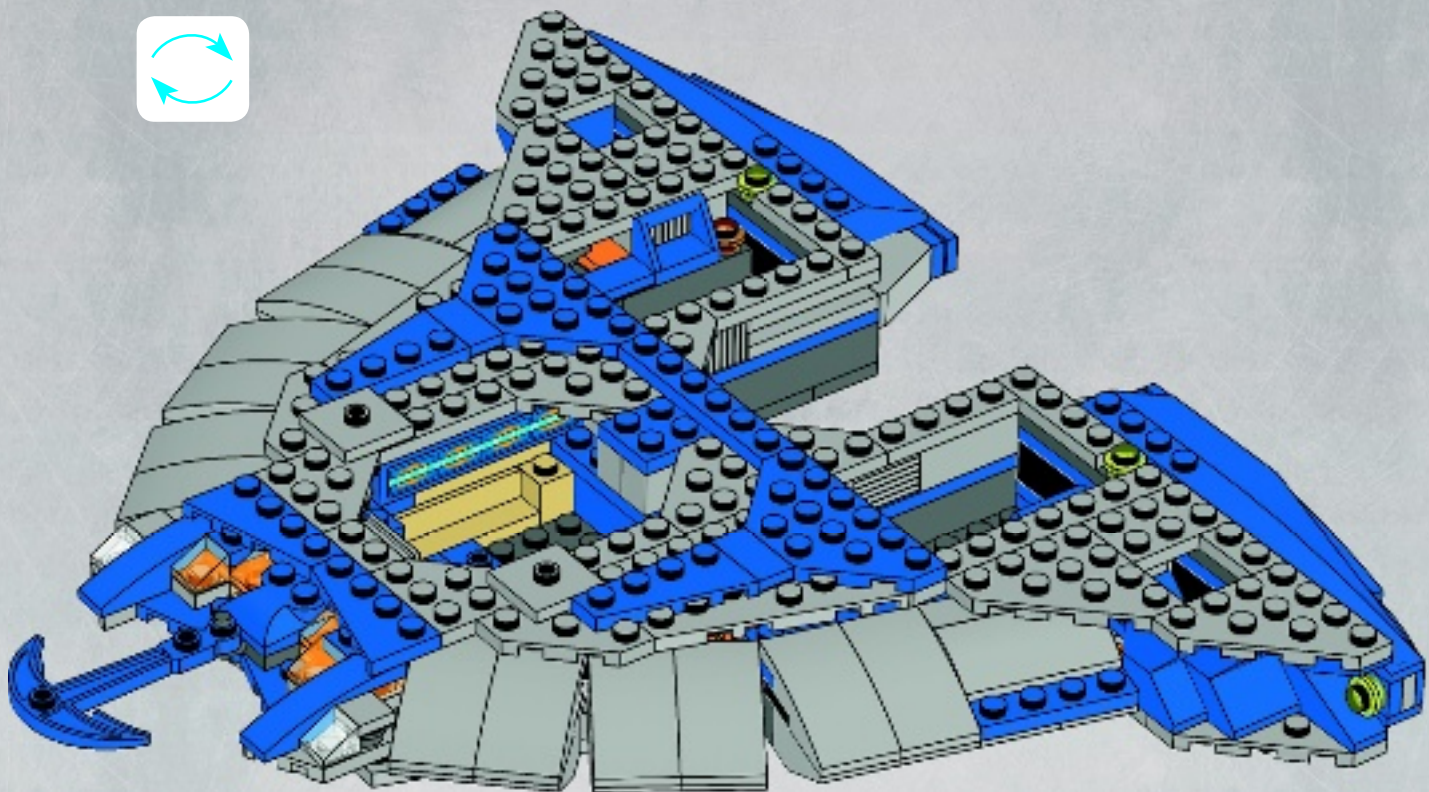

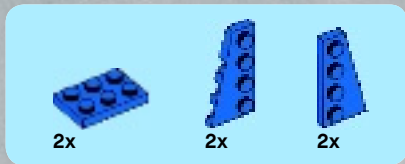

42

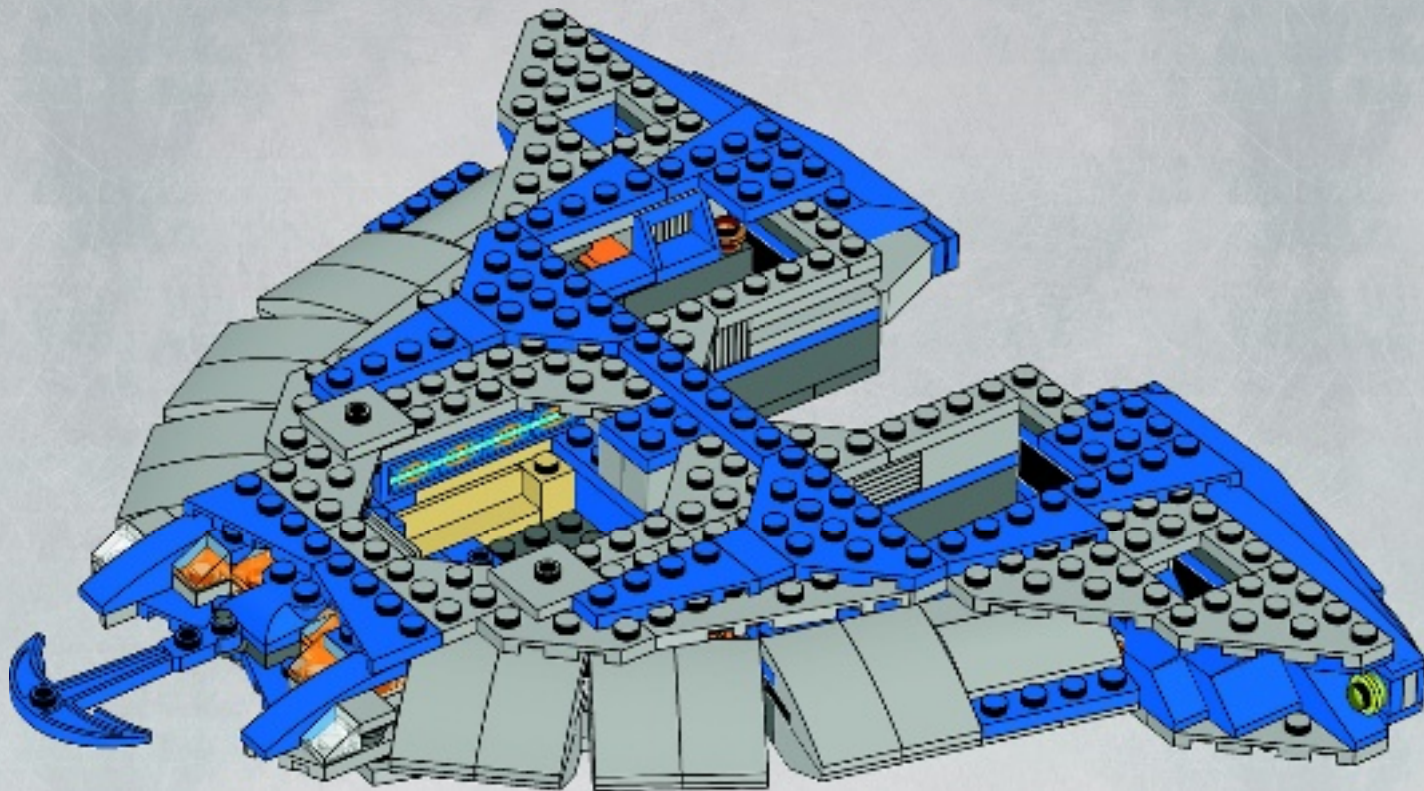





# 43

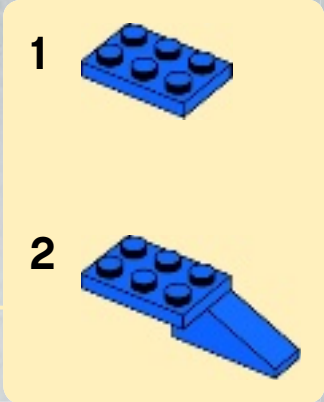
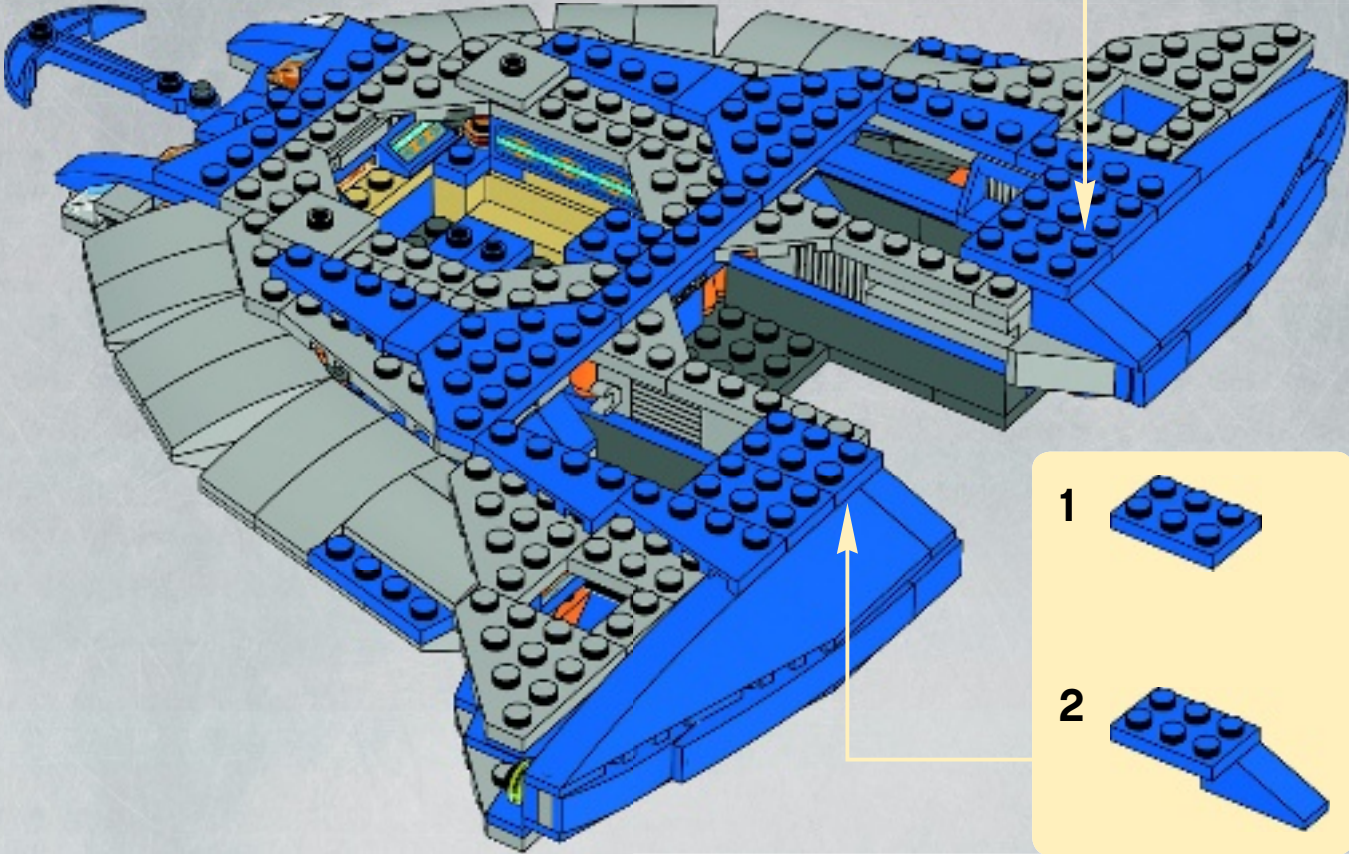
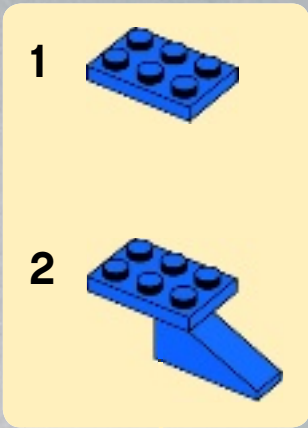



2x



8x

# 44

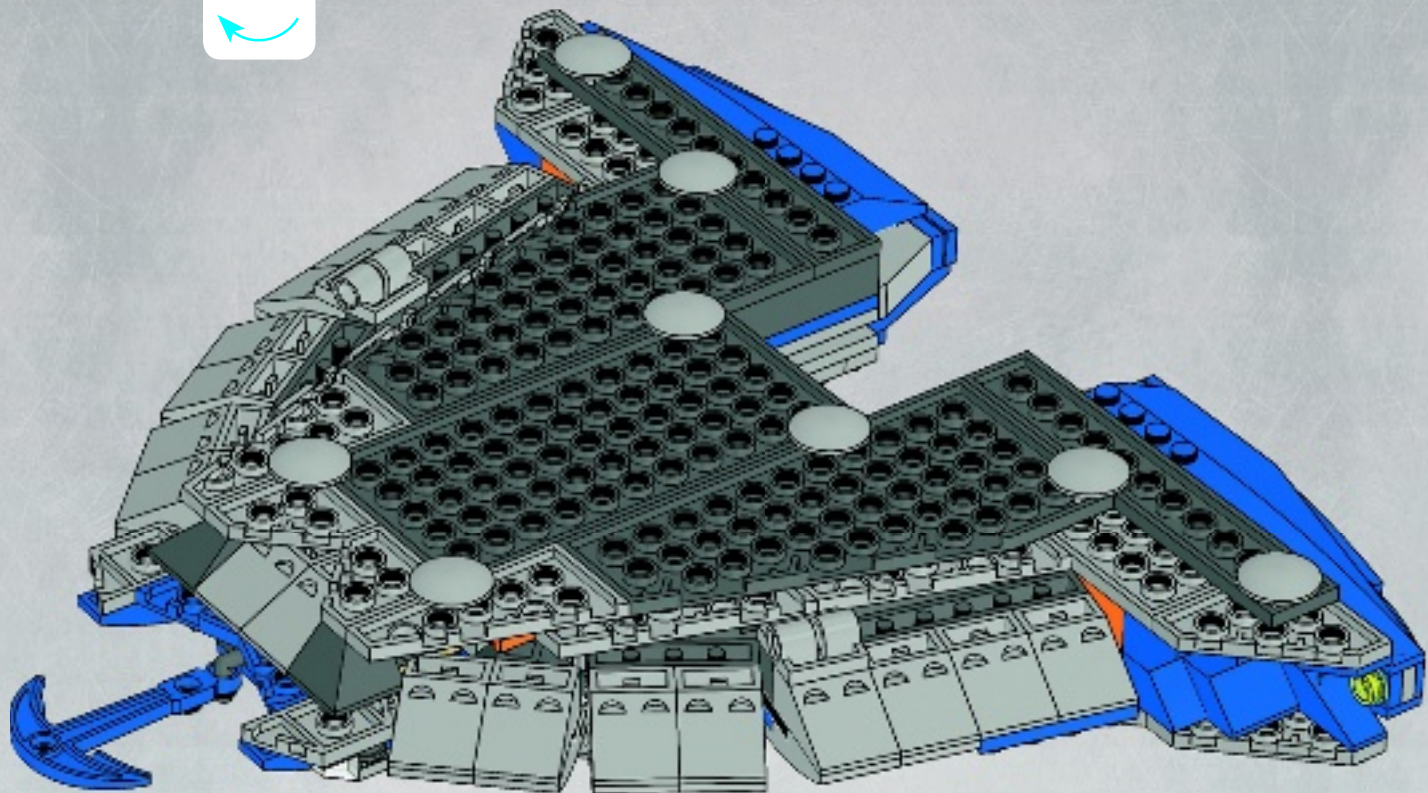



2x



2x

# 45



2x

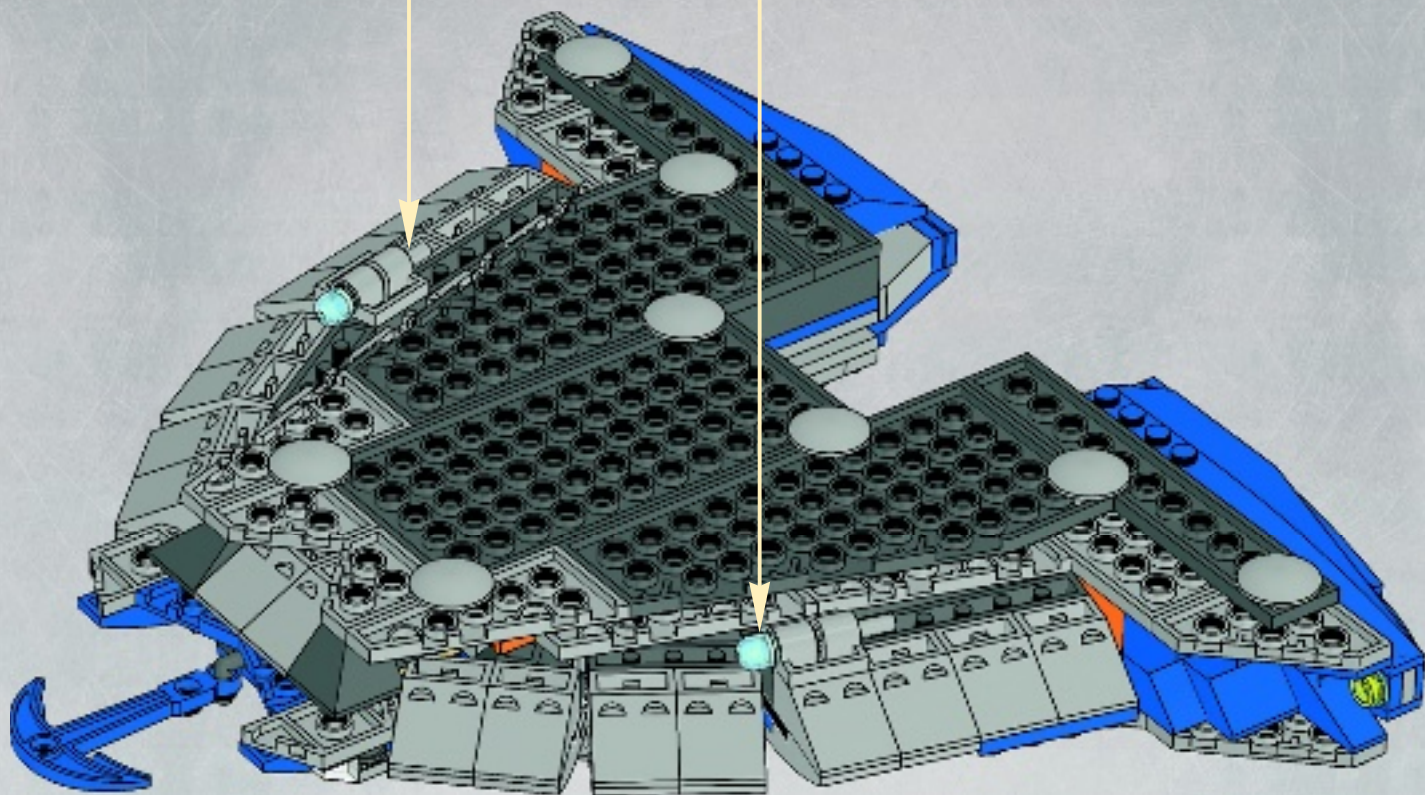



2x



6x

# 46

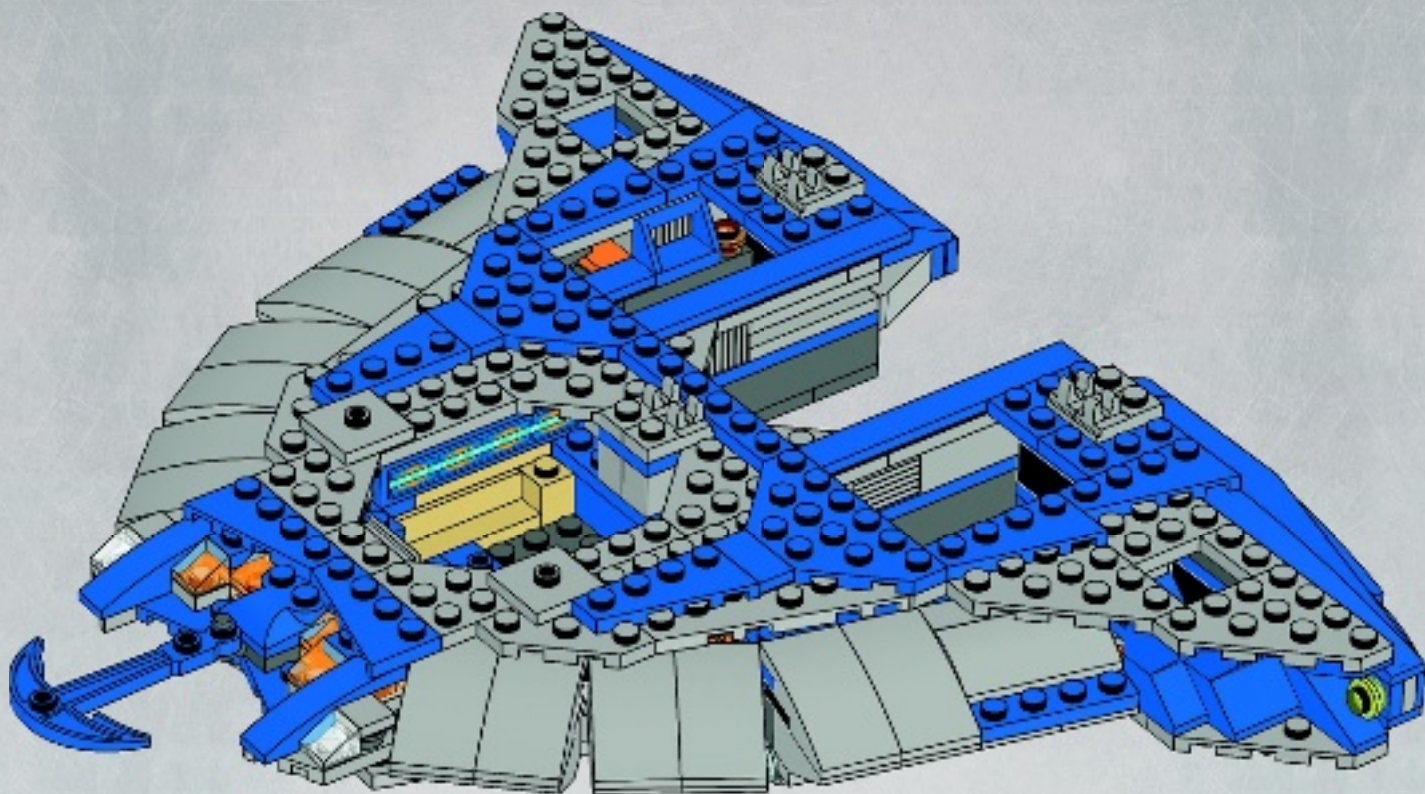



2x

47

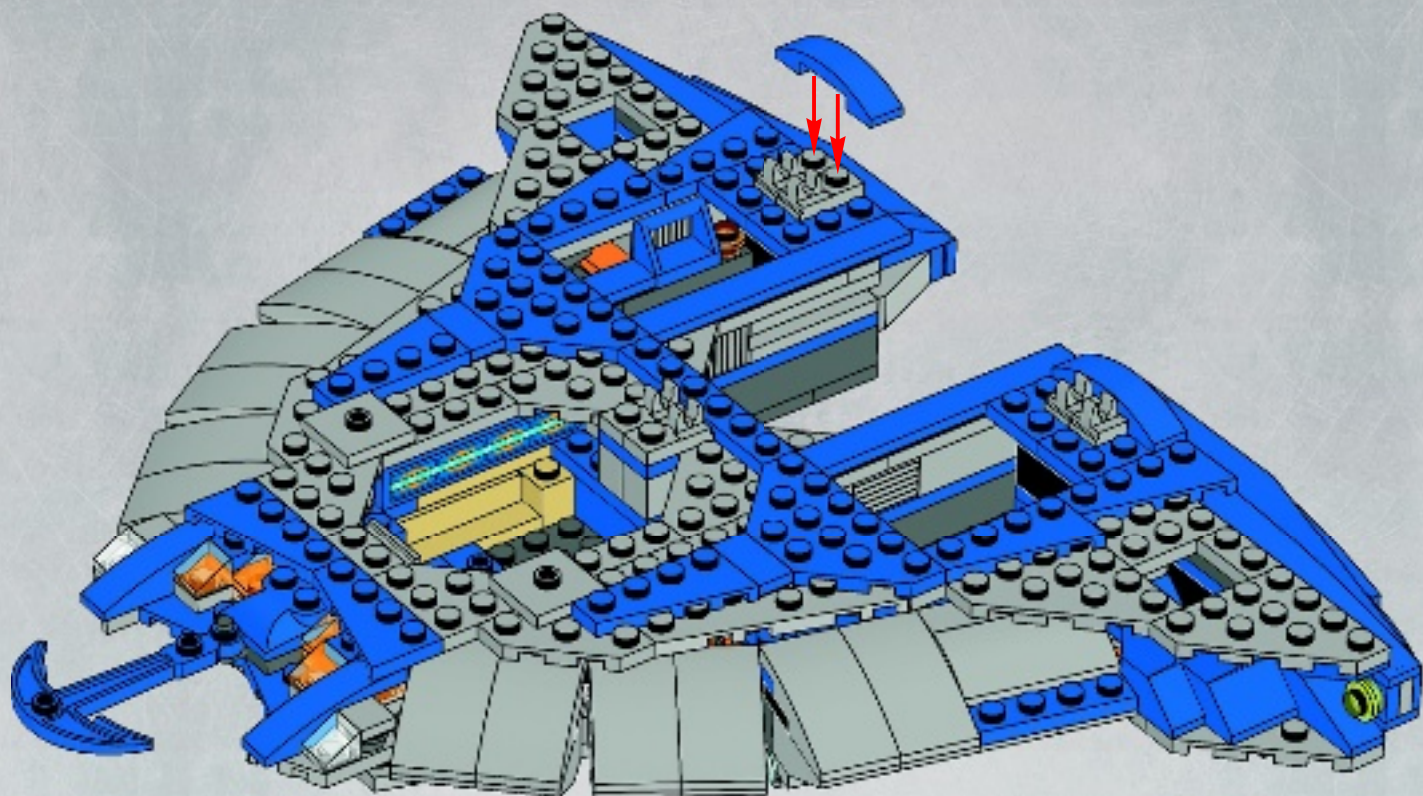



3x

# 48

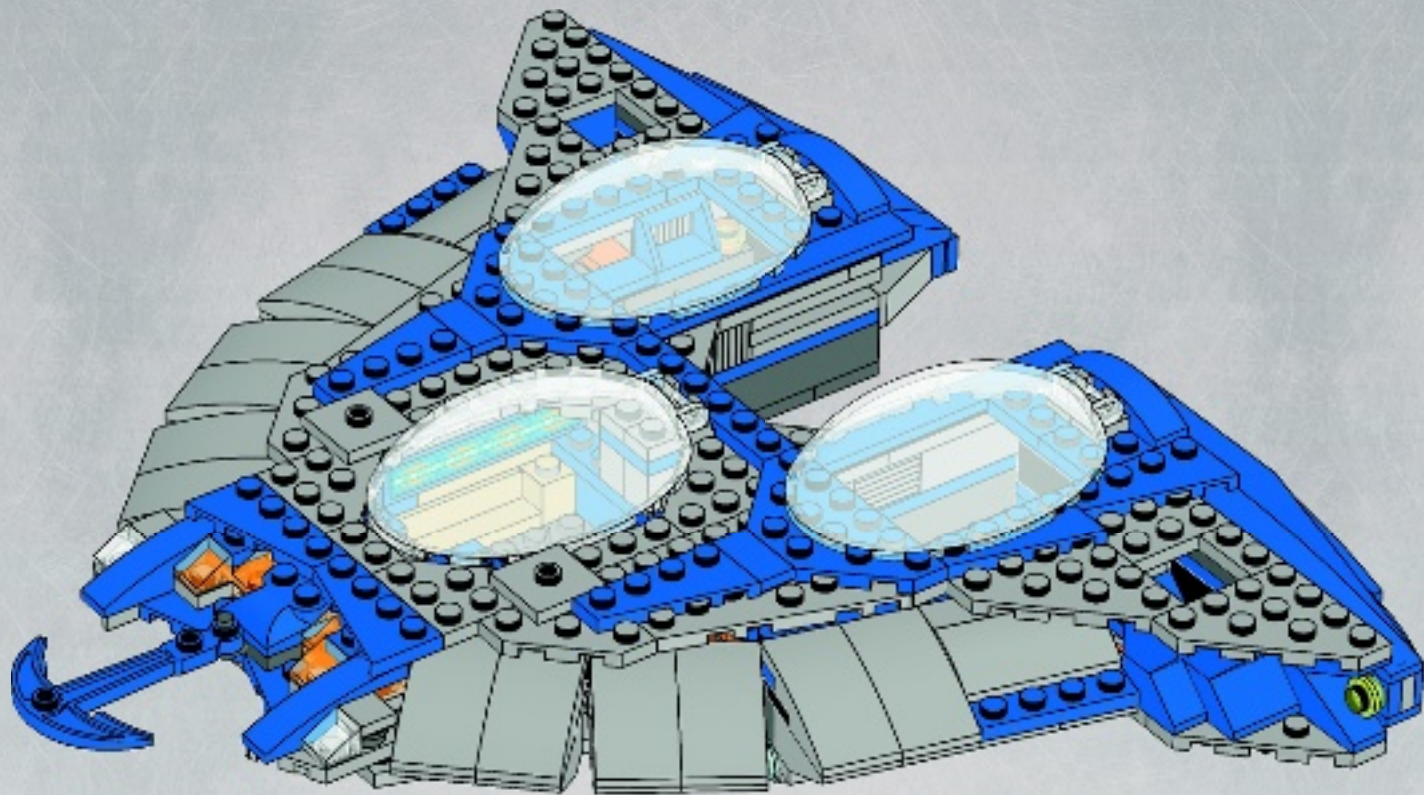

49

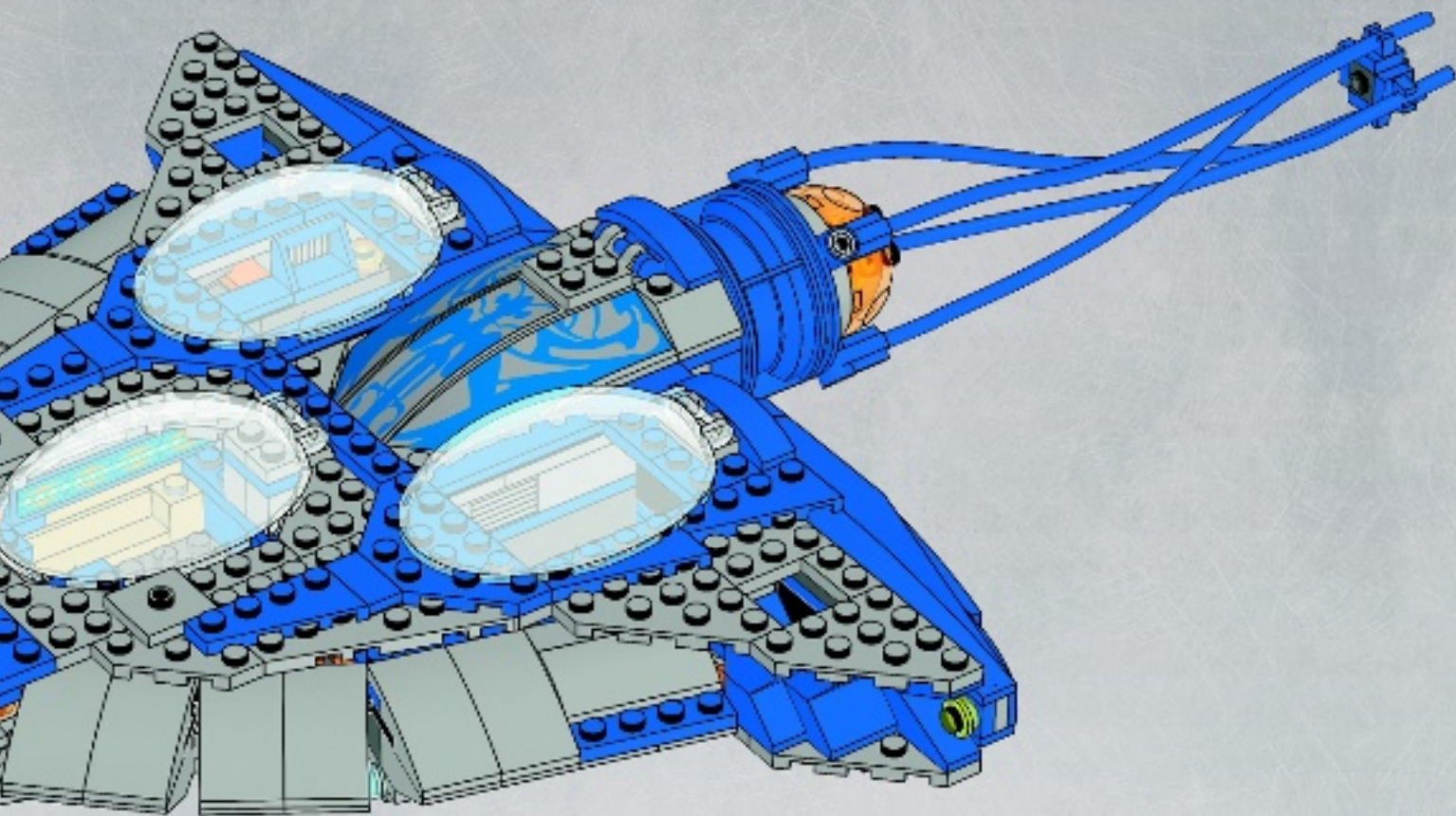

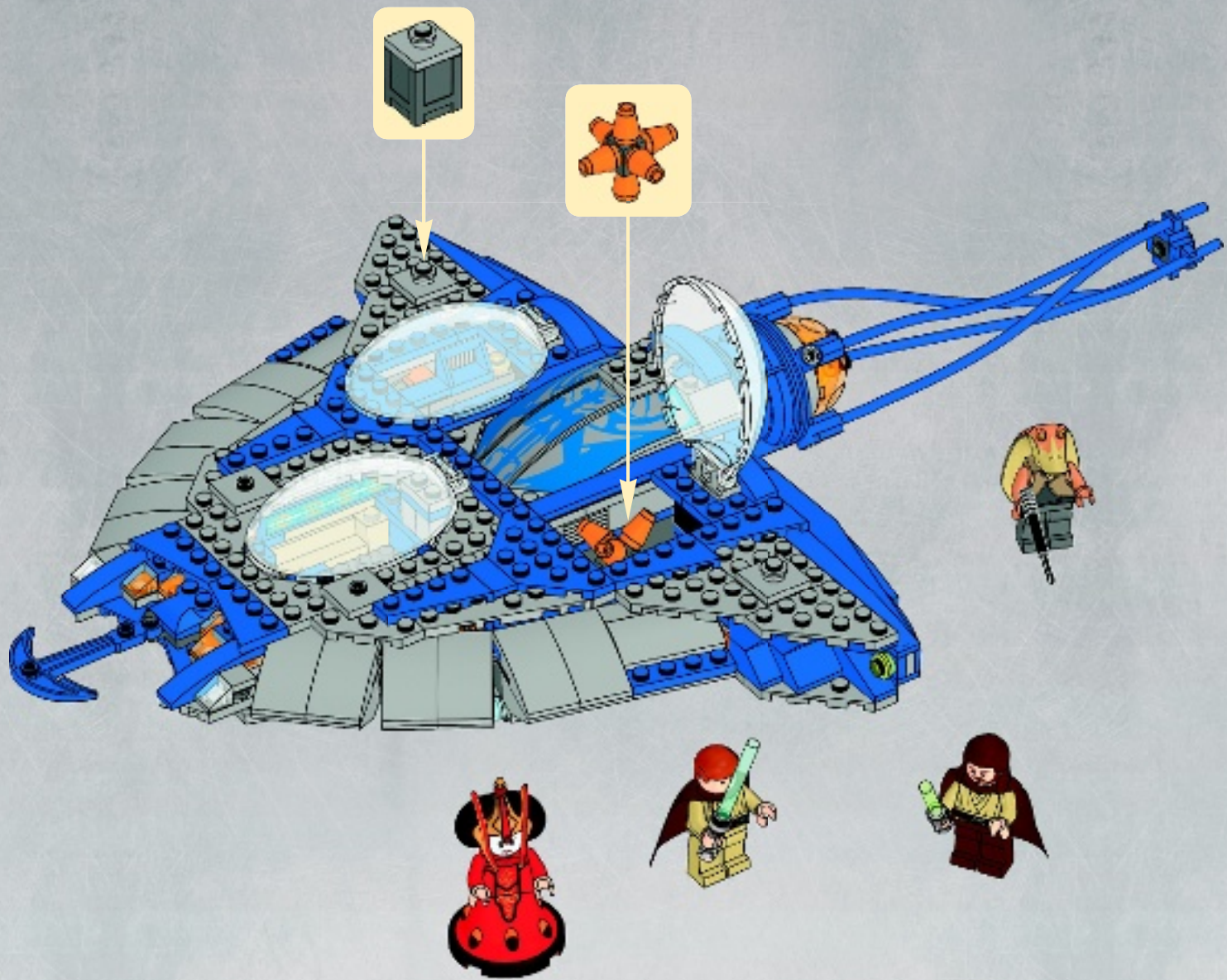



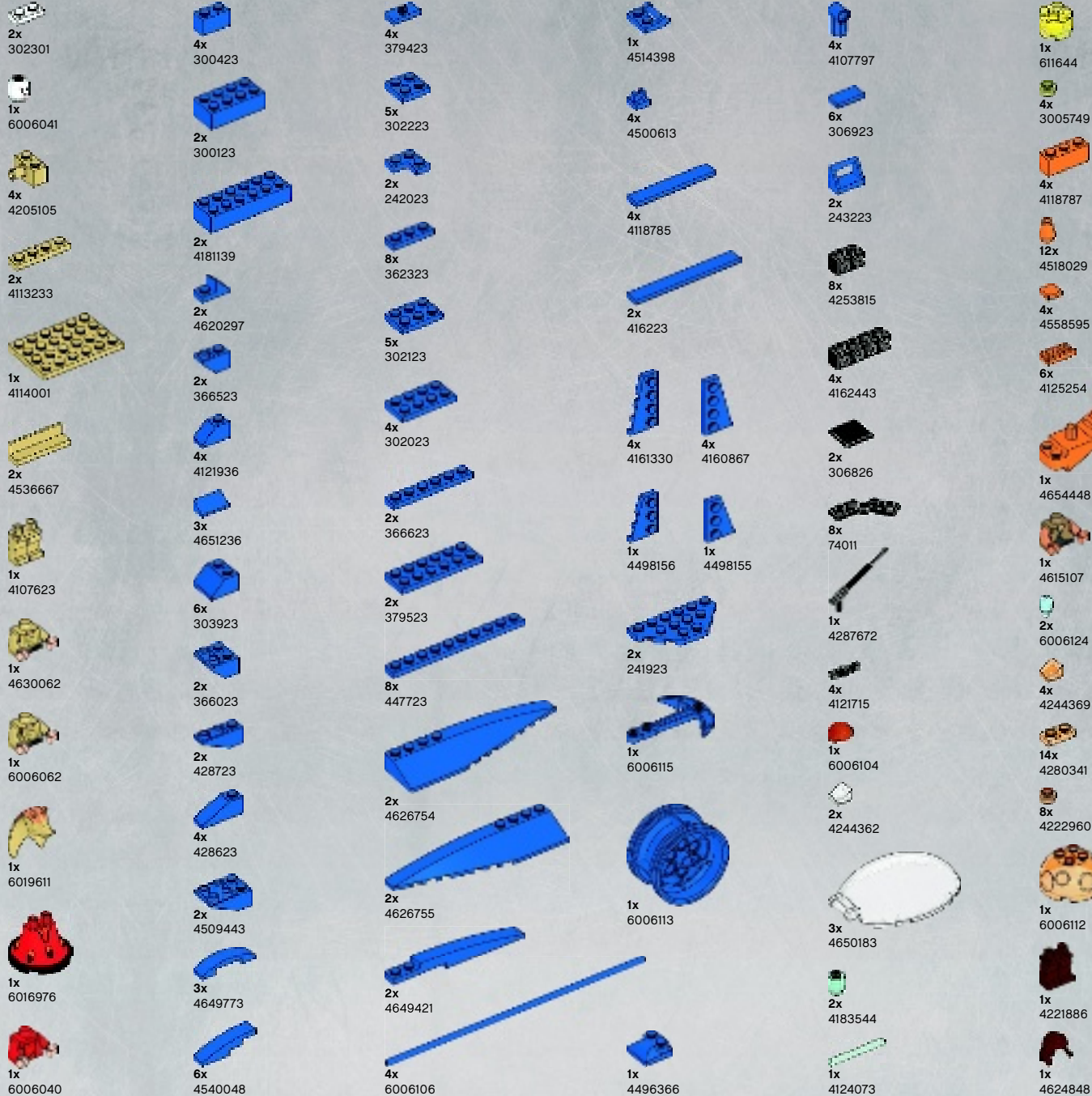

1x  
4227505

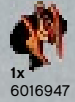

1x  
6016947



1x  
6006051



1x  
6006053



2x  
4548731



1x  
4626400



2x  
4535738



2x  
4211376



2x  
4211356



8x  
4211525



9x  
4278273



2x  
4535764



11x  
4211383



2x  
4211694



6x  
4211613



4x  
4650645



1x  
4211527



2x  
4515374



3x  
4211410



18x  
4211570



12x  
4622742

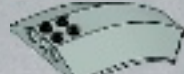

1x  
6006105



1x  
4550252



2x  
4211442

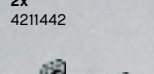

4x  
4282789



4x  
4282786

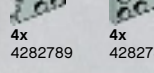

2x  
4211452



2x  
4211425

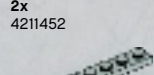

2x  
4211404

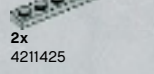

2x  
4514846



7x  
4211445



4x  
4211398



4x  
4565393



2x  
4211397



5x  
4211396



2x  
4211415



6x  
4598526



3x  
4211568



2x  
4507056



6x  
4211361



2x  
4211352



6x  
4160560



2x  
4597901



2x  
4520320



2x  
4271950



2x  
4271950



2x  
4520307



2x  
4211103



2x  
4211085

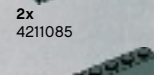

4x  
4211099



2x  
4210700



2x  
4287972



2x  
4287973



2x  
4211111



2x  
4210862



2x  
4211000



2x  
4651871



2x  
4210779



1x  
4211065



2x  
4211002



1x  
4222693



1x  
4611703



1x  
4227517



2x  
4210633



6x  
4527082

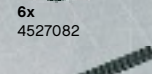

1x  
4499858

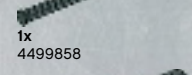

2x  
4257526



2x  
4211067



1x  
4256149



1x  
4271542



1x  
4271543



**Customer Service**  
**Kundenservice**  
**Service Consommateurs**  
**Servicio Al Consumidor**  
**LEGO.com/service or dial**



00800 5346 5555 :

1-800-422-5346 :



QUEEN AMIDALA™



QUI-GON JINN™



JAR JAR BINKS™



OBI-WAN KENOBI™

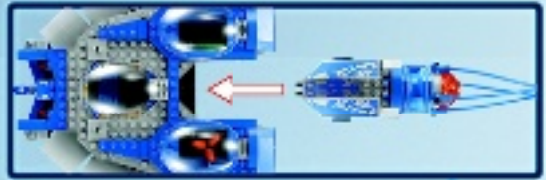



9496



9498



9497



9499



9500



9515



9516



9496



9496



9496



9496



9497



9497



9497



9498



9498



9498



9499



9499



9499



9499



9500



9500



9500



9515



9515



9515



9515



9515



9515



9516



9516



9516



9516



9516



9516



9516



9516



9516



9516



1



2



3

[www.LEGOclub.com/Max](http://www.LEGOclub.com/Max)

[www.LEGOclub.com/Max](http://www.LEGOclub.com/Max)



**club**™

**FREE\*! GRATIS! GRATUIT!**

\*Paid subscription in Australia and New Zealand.  
\*Abonnement payant en Australie et Nouvelle-Zélande.



[starwars.LEGO.com](http://starwars.LEGO.com)